

SURFACE MOUNT SUPER FAST RECTIFIER

VOLTAGE RANGE 50 to 400 Volts CURRENT 0.5 Ampere

FEATURES

- * High reliability
- * Low leakage
- * Low forward voltage
- * High current capability
- * Super fast switching speed
- * High surge capability
- * Good for switching mode circuit

MECHANICAL DATA

- * Case: Molded plastic
- * Epoxy: Device has UL flammability classification 94V-0
- * Lead: MIL-STD-202E method 208C guaranteed
- * Mounting position: Any
- * Weight: 0.016 gram

MAXIMUM RATINGS AND ELECTRICAL CHARACTERISTICS

Ratings at 25 °C ambient temperature unless otherwise specified.
 Single phase, half wave, 60 Hz, resistive or inductive load.
 For capacitive load, derate current by 20%.



SOD-123FL

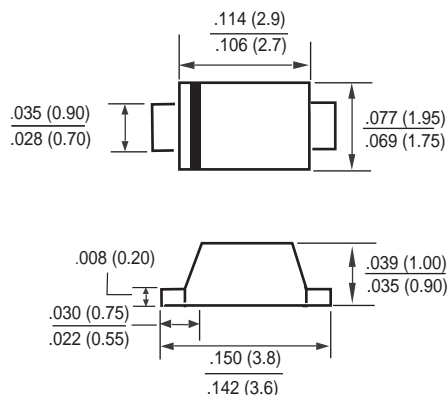

Dimensions in inches and (millimeters)

MAXIMUM RATINGS (At TA = 25°C unless otherwise noted)

RATINGS		SYMBOL	05E1L	05E2L	05E3L	05E4L	05E5L	05E6L	UNITS
Maximum Recurrent Peak Reverse Voltage		VRRM	50	100	150	200	300	400	Volts
Maximum RMS Volts		VRMS	35	70	105	140	210	280	Volts
Maximum DC Blocking Voltage		Vdc	50	100	150	200	300	400	Volts
Maximum Average Forward Current at TA = 55°C		Io	0.5						Amps
Peak Forward Surge Current IFM (surge):8.3 ms single half sine-wave superimposed on rated load (JEDEC method)		IFSM	15						Amps
Typical Junction Capacitance (Note 2)		Cj	12			14			pF
Operating and Storage Temperature Range		TJ, TSTG	-55 to +150						°C

ELECTRICAL CHARACTERISTICS (At TA = 25°C unless otherwise noted)

CHARACTERISTICS		SYMBOL	05E1L	05E2L	05E3L	05E4L	05E5L	05E6L	UNITS
Maximum Forward Voltage at 0.5A DC		VF	0.95			1.25			Volts
Maximum DC Reverse Current at Rated DC Blocking Voltage	@ TA = 25°C	IR	5.0						uAmps
	@ TA = 100°C		100						
Maximum Reverse Recovery Time (Note 1)		trr	35						nSec

NOTES : 1. Test Conditions: IF=0.5A, IR=-1.0A, IRR=-0.25A.
 2. Measured at 1 MHz and applied reverse voltage of 4.0 volts.
 3."Fully ROHS compliant", "100% Sn plating (Pb-free)".

RATING AND CHARACTERISTIC CURVES (05E1L THRU 05E6L)

FIG. 1 - TEST CIRCUIT DIAGRAM AND REVERSE RECOVERY TIME CHARACTERISTIC

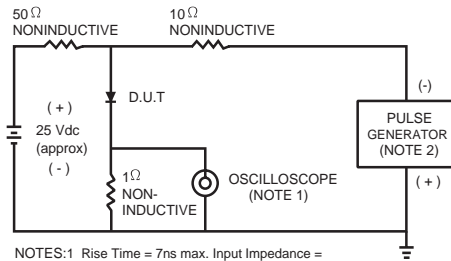

NOTES: 1. Rise Time = 7ns max. Input Impedance = 1 megohm, 22pF.
2. Rise Time = 10ns max. Source Impedance = 50 ohms.

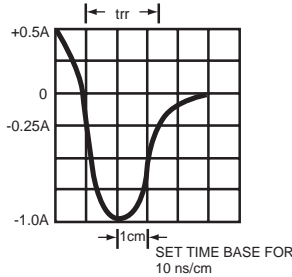

FIG. 2 - TYPICAL FORWARD CURRENT DERATING CURVE

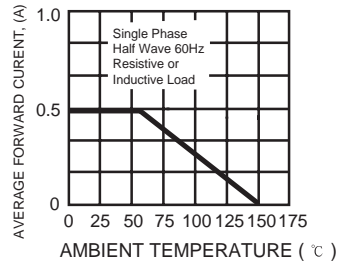

FIG. 3 - TYPICAL REVERSE CHARACTERISTICS

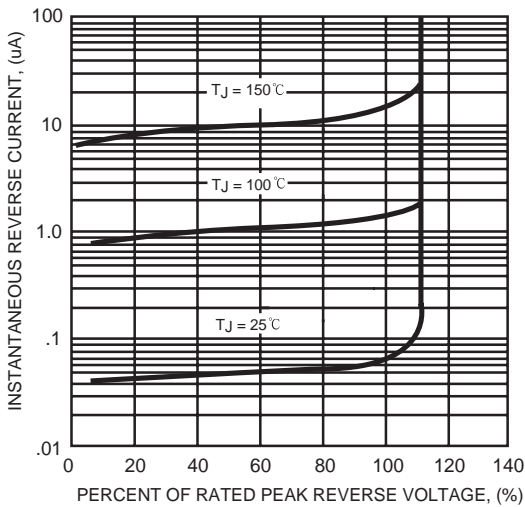

FIG. 4 - TYPICAL INSTANTANEOUS FORWARD CHARACTERISTICS

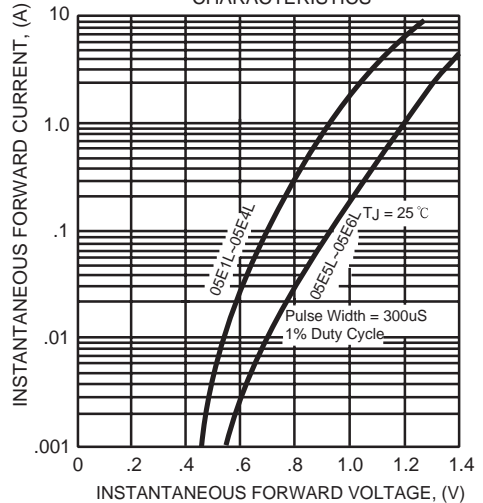

FIG. 5 - MAXIMUM NON-REPETITIVE FORWARD SURGE CURRENT

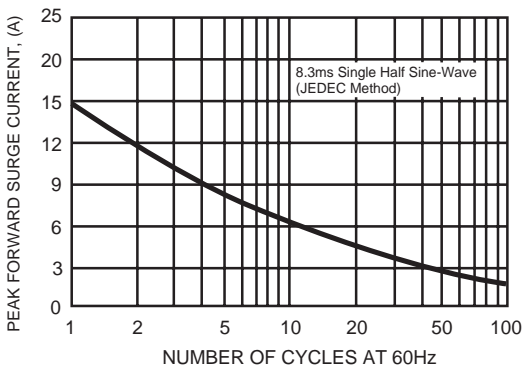
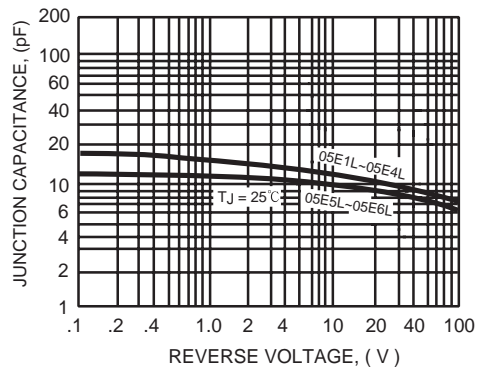
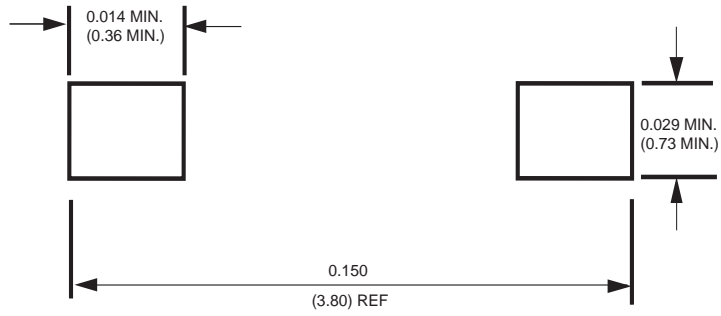

FIG. 6 - TYPICAL JUNCTION CAPACITANCE



Mounting Pad Layout



Dimensions in inches and (millimeters)