

SUPER LOW Vf SCHOTTKY BARRIER RECTIFIER

VOLTAGE RANGE 20 to 40 Volts CURRENT 1.0 Ampere

FEATURES

- * Low switching noise
- * Low forward voltage drop
- * High current capability
- * High switching capability
- * High surge capability
- * High reliability

MECHANICAL DATA

- * Case: Molded plastic
- * Epoxy: Device has UL flammability classification 94V-0
- * Lead: MIL-STD-202E method 208C guaranteed
- * Metallurgically bonded construction
- * Mounting position: Any
- * Weight: 0.09 gram

MAXIMUM RATINGS AND ELECTRICAL CHARACTERISTICS

Ratings at 25 °C ambient temperature unless otherwise specified.
Single phase, half wave, 60 Hz, resistive or inductive load.
For capacitive load, derate current by 20%.

NEW RELEASE



DO-214AC

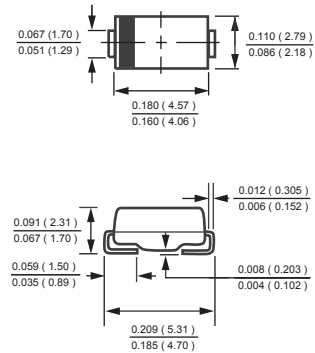

Dimensions in inches and (millimeters)

MAXIMUM RATINGS (@ TA=25 °C unless otherwise noted)

RATINGS	SYMBOL	FML120	FML130	FML140	UNITS
Maximum Recurrent Peak Reverse Voltage	V _{RRM}	20	30	40	Volts
Maximum RMS Voltage	V _{RMS}	14	21	28	Volts
Maximum DC Blocking Voltage	V _{DC}	20	30	40	Volts
Maximum Average Forward Rectified Current at T _A =75°C	I _O		1.0		Amps
Peak Forward Surge Current 8.3 ms single half sine-wave superimposed on rated load (JEDEC method)	I _{FSM}		40		Amps
Typical Thermal Resistance (Note 1)	R _{θJA}		85		°C/W
Typical Thermal Resistance (Note 1)	R _{θJL}		25		°C/W
Typical Junction Capacitance (Note 2)	C _J		110		pF
Operating Temperature Range	T _J		150		°C
Storage Temperature Range	T _{STG}		-55 to + 150		°C

ELECTRICAL CHARACTERISTICS (@TA=25 °C unless otherwise noted)

CHARACTERISTICS	SYMBOL	FML120	FML130	FML140	UNITS
Maximum Instantaneous Forward Voltage at 1.0A DC	V _F		.36		Volts
Maximum Average Reverse Current at Rated DC Blocking Voltage	@T _A = 25°C		1.0		mA
	@T _A = 100°C		10		mA

- NOTES : 1. Thermal Resistance : Mounted on PCB.
 2. Measured at 1 MHz and applied reverse voltage of 4.0 volts.
 3. Also available in DO-214AA (SMB).
 4. "Fully ROHS compliant", "100% Sn plating (Pb-free)".

RATING AND CHARACTERISTICS CURVES (FML120 THRU FML140)

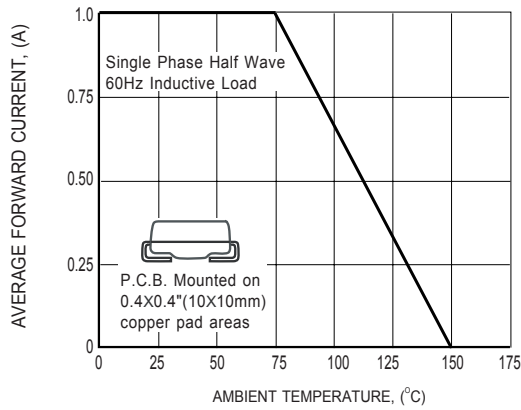

FIG.1 TYPICAL FORWARD CURRENT DERATING CURVE

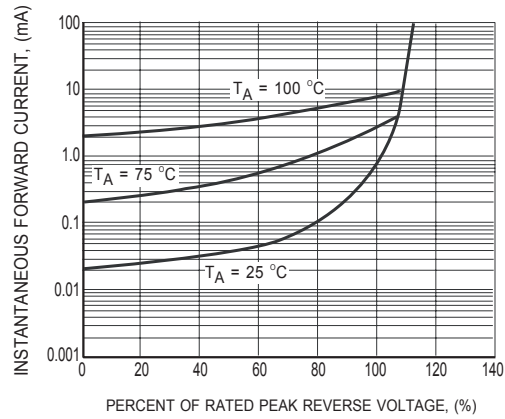

FIG.2 TYPICAL REVERSE CHARACTERISTICS

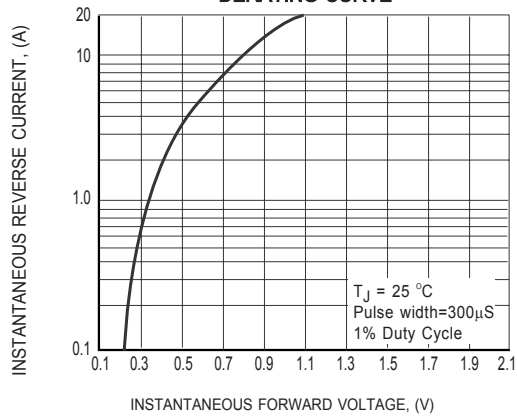

FIG.3 TYPICAL INSTANTANEOUS FORWARD CHARACTERISTICS

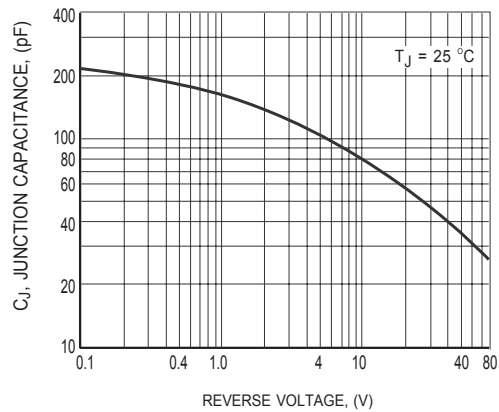

FIG.4 TYPICAL JUNCTION CAPACITANCE

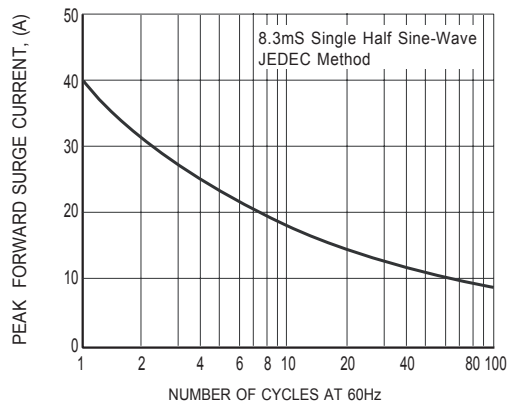
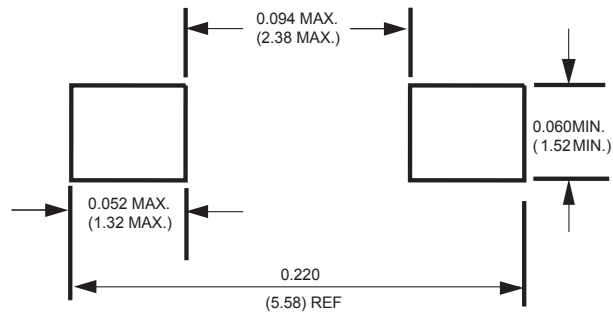

FIG.5 MAXIMUM NON-REPETITIVE FORWARD SURGE CURRENT

Mounting Pad Layout



Dimensions in inches and (millimeters)

DISCLAIMER NOTICE

Rectron Inc reserves the right to make changes without notice to any product specification herein, to make corrections, modifications, enhancements or other changes. Rectron Inc or anyone on its behalf assumes no responsibility or liability for any errors or inaccuracies. Data sheet specifications and its information contained are intended to provide a product description only. "Typical" parameters which may be included on RECTRON data sheets and/ or specifications can and do vary in different applications and actual performance may vary over time. Rectron Inc does not assume any liability arising out of the application or use of any product or circuit.

Rectron products are not designed, intended or authorized for use in medical, life-saving implant or other applications intended for life-sustaining or other related applications where a failure or malfunction of component or circuitry may directly or indirectly cause injury or threaten a life without expressed written approval of Rectron Inc. Customers using or selling Rectron components for use in such applications do so at their own risk and shall agree to fully indemnify Rectron Inc and its subsidiaries harmless against all claims, damages and expenditures.