

**SINGLE-PHASE GLASS PASSIVATED  
SILICON BRIDGE RECTIFIER**  
VOLTAGE RANGE 50 to 1000 Volts CURRENT 10.0 Ampere

**FEATURES**

- \* Low leakage
- \* Low forward voltage
- \* Silver-plated copper leads
- \* Surge overload rating: 200 amperes peak
- \* Mounting position: Any

**MECHANICAL DATA**

- \* Epoxy: Device has UL flammability classification 94V-0

NEW RELEASE

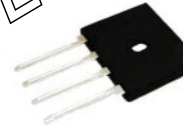

RBU

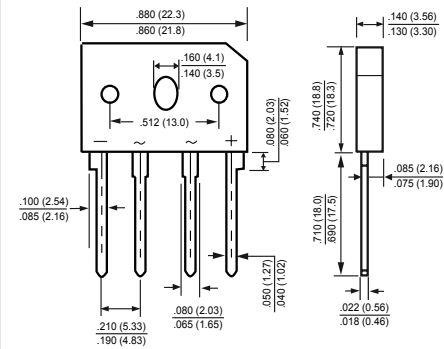

**MAXIMUM RATINGS AND ELECTRICAL CHARACTERISTICS**

Ratings at 25 °C ambient temperature unless otherwise specified.

Single phase, half wave, 60 Hz, resistive or inductive load.

For capacitive load, derate current by 20%.

**MAXIMUM RATINGS (@ TA=25 °C unless otherwise noted)**

RATINGS	SYMBOL	RBU1001M	RBU1002M	RBU1003M	RBU1004M	RBU1005M	RBU1006M	RBU1007M	UNITS
Maximum Recurrent Peak Reverse Voltage	$V_{RRM}$	50	100	200	400	600	800	1000	Volts
Maximum RMS Voltage	$V_{RMS}$	35	70	140	280	420	560	700	Volts
Maximum DC Blocking Voltage	$V_{DC}$	50	100	200	400	600	800	1000	Volts
Maximum Average Forward Rectified Current at $T_C = 100^\circ\text{C}$ (Note 4)	$I_O$	10.0							Amps
Peak Forward Surge Current 8.3 ms single half sine-wave superimposed on rated load (JEDEC method)	$I_{FSM}$	200							Amps
Typical Thermal Resistance (Note 1)	$R_{\theta JC}$	2.3							°C/W
	$R_{\theta JA}$	26							
Operating and Storage Temperature Range	$T_J, T_{STG}$	-55 to + 150							°C

**ELECTRICAL CHARACTERISTICS (@ TA=25 °C unless otherwise noted)**

CHARACTERISTICS	SYMBOL	RBU1001M	RBU1002M	RBU1003M	RBU1004M	RBU1005M	RBU1006M	RBU1007M	UNITS
Maximum Instantaneous Forward Voltage at 5.0A DC	$V_F$	1.1							Volts
Maximum DC Reverse Current at Rated DC Blocking Voltage	@ $T_A = 25^\circ\text{C}$	2.0							$\mu\text{Amps}$
	@ $T_A = 100^\circ\text{C}$	100							

- NOTES : 1. Thermal Resistance : Heat-sink case mounted or if PCB mounted.  
2. "Fully ROHS compliant", "100% Sn plating (Pb-free)".  
3. Equivalent to Vishay's GBU10 Series.  
4. \*\*\* Heat Sink Temperature.

# RATING AND CHARACTERISTICS CURVES ( RBU1001M THRU RBU1007M )

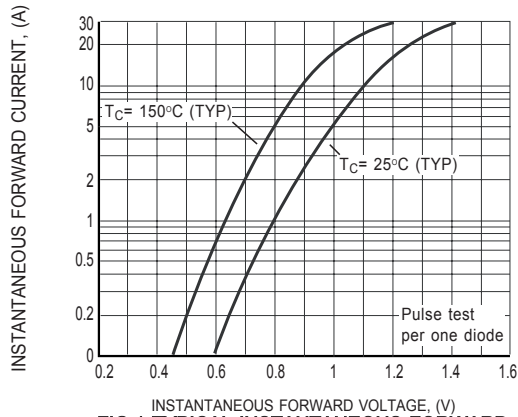

**FIG.1 TYPICAL INSTANTANEOUS FORWARD CHARACTERISTICS**

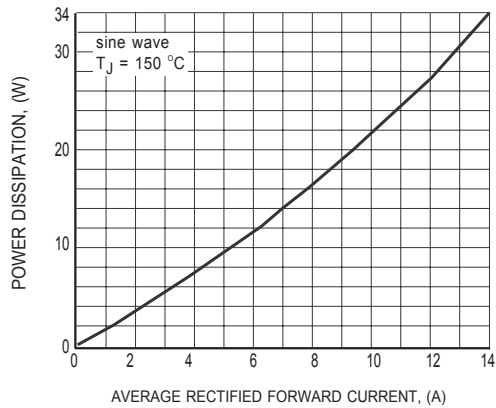

**FIG.2 POWER DISSIPATION**

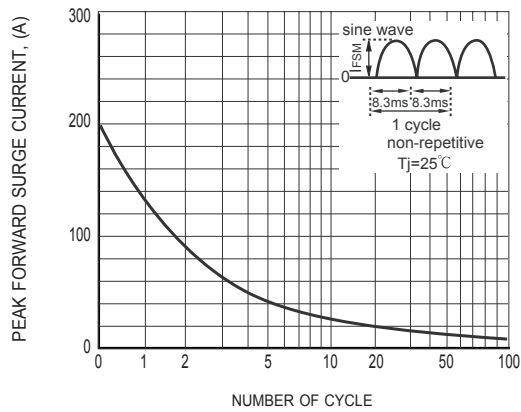

**FIG.3 SURGE FORWARD CURRENT CAPABILITY**

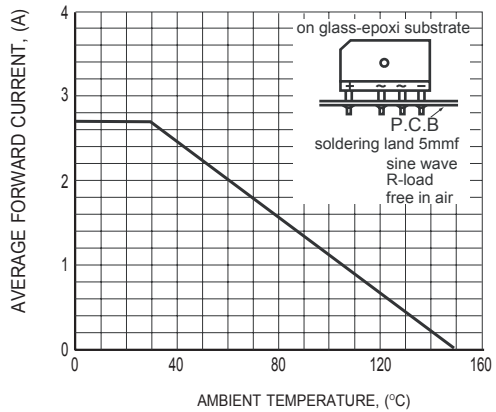

**FIG.4 TYPICAL FORWARD CURRENT DERATING CURVE**

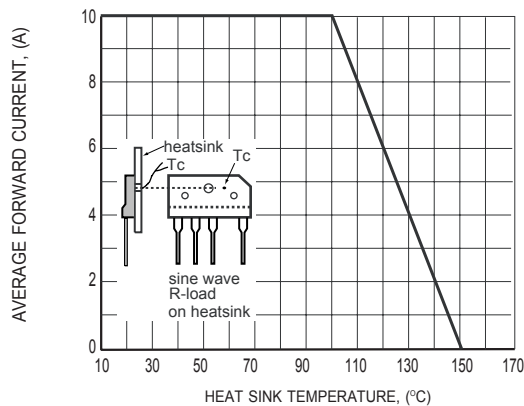

**FIG.5 TYPICAL FORWARD CURRENT DERATING CURVE**

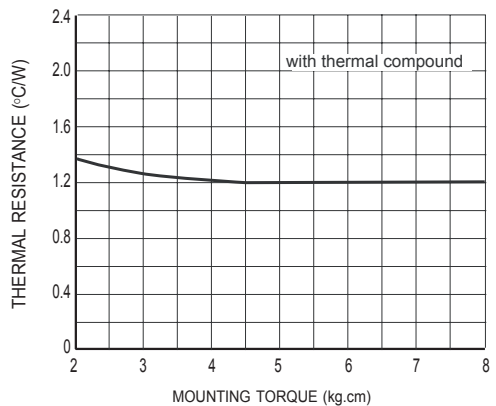

**FIG.6 CONTACT THERMAL RESISTANCE fcf**

## DISCLAIMER NOTICE

Rectron Inc reserves the right to make changes without notice to any product specification herein, to make corrections, modifications, enhancements or other changes. Rectron Inc or anyone on its behalf assumes no responsibility or liability for any errors or inaccuracies. Data sheet specifications and its information contained are intended to provide a product description only. "Typical" parameters which may be included on RECTRON data sheets and/ or specifications can and do vary in different applications and actual performance may vary over time. Rectron Inc does not assume any liability arising out of the application or use of any product or circuit.

Rectron products are not designed, intended or authorized for use in medical, life-saving implant or other applications intended for life-sustaining or other related applications where a failure or malfunction of component or circuitry may directly or indirectly cause injury or threaten a life without expressed written approval of Rectron Inc. Customers using or selling Rectron components for use in such applications do so at their own risk and shall agree to fully indemnify Rectron Inc and its subsidiaries harmless against all claims, damages and expenditures.