

SILICON RECTIFIER

VOLAGE RANGE 50 to 600 Volts CURRENT 15 Ampere

FEATURES

- * Low cost
- * Low leakage
- * Low forward voltage drop
- * High current capability
- * High surge current capability
- * Ideal for solar panel PV application such as By-Pass diode

MECHANICAL DATA

- * Case: Molded plastic
- * Epoxy: Device has UL flammability classification 94V-O
- * Lead: MIL-STD-202E method 208C guaranteed
- * Mounting position: Any
- * Weight: 2.08 grams

MAXIMUM RATINGS AND ELECTRICAL CHARACTERISTICS

Ratings at 25 °C ambient temperature unless otherwise specified.
resistive or inductive load.



R-7

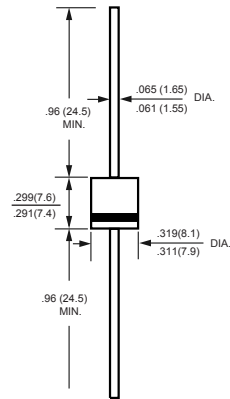

Dimensions in inches and (millimeters)

MAXIMUM RATINGS (At TA = 25°C unless otherwise noted)

RATINGS	SYMBOL	SPA1501	SPA1502	SPA1503	SPA1504	SPA1505	UNITS	
Maximum Recurrent Peak Reverse Voltage	VRRM	50	100	200	400	600	Volts	
Maximum RMS Voltage	VRMS	35	70	140	280	480	Volts	
Maximum DC Blocking Voltage	VDC	50	100	200	400	600	Volts	
Maximum DC Forward Current @TL=125°C(Note 2)	IO	15						Amps
Peak Forward Surge Current 8.3 ms single half sine-wave superimposed on rated load (JEDEC method)	IFSM	400						Amps
Typical Current Squared Time	I ² T	663.7						A ² S
Typical Junction Capacitance (Note)	CJ	125						pF
Typical Thermal Resistance	RθJA	7						°C/W
Operating Temperature Range	TJ	175(TJ≤200°C in Bypass Mode)						°C
Storage Temperature Range	TSTG	-55 to +175						°C

ELECTRICAL CHARACTERISTICS (At TA = 25°C unless otherwise noted)

CHARACTERISTICS	SYMBOL	SPA1501	SPA1502	SPA1503	SPA1504	SPA1505	UNITS	
Maximum Instantaneous Forward Voltage at 15A DC	VF	1.0						Volts
Maximum DC Reverse Current at Rated DC Blocking Voltage	@TA = 25°C	10						uAmps
	@TA = 100°C	100						
Maximum Full Load Reverse Current Average Full Cycle .375" (9.5mm) lead length at TL = 75°C	IR	50						uAmps

NOTES : 1. Measured at 1 MHz and applied reverse voltage of 4.0 volts
2. Heat-sink mounted 10mm max from body

2009-10
REV:0

RATING AND CHARACTERISTIC CURVES (SPA1501 THRU SPA1505)

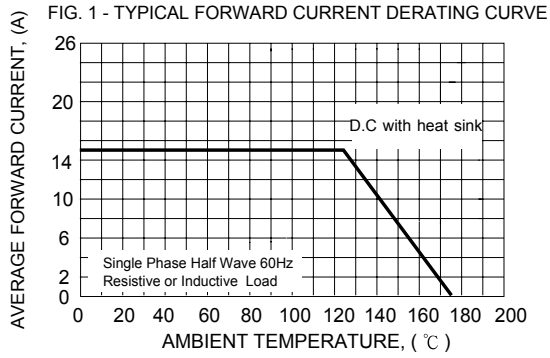

FIG. 2 - TYPICAL INSTANTANEOUS FORWARD CHARACTERISTICS

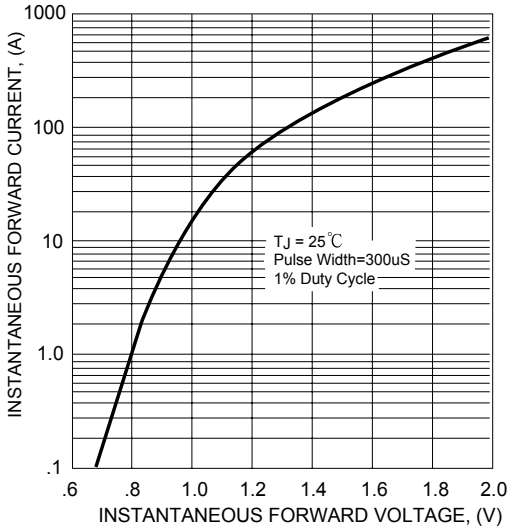

FIG. 3 - TYPICAL REVERSE CHARACTERISTICS

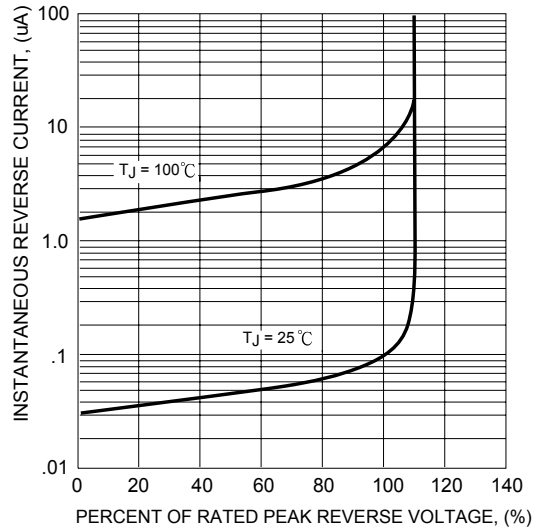

FIG. 3 - MAXIMUM NON-REPETITIVE FORWARD SURGE CURRENT

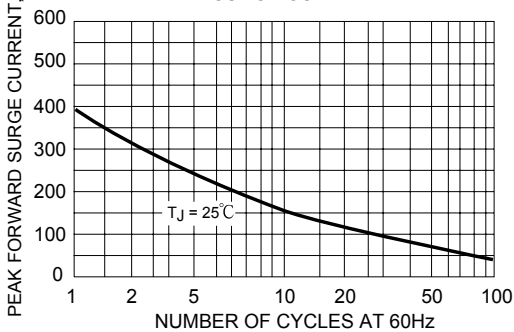
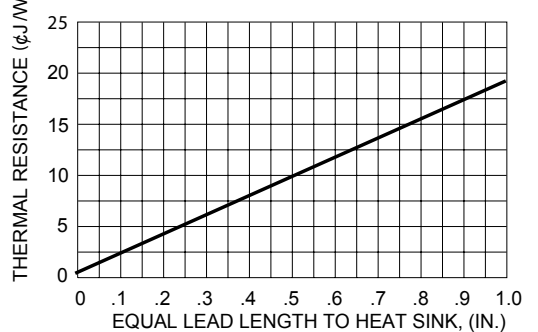
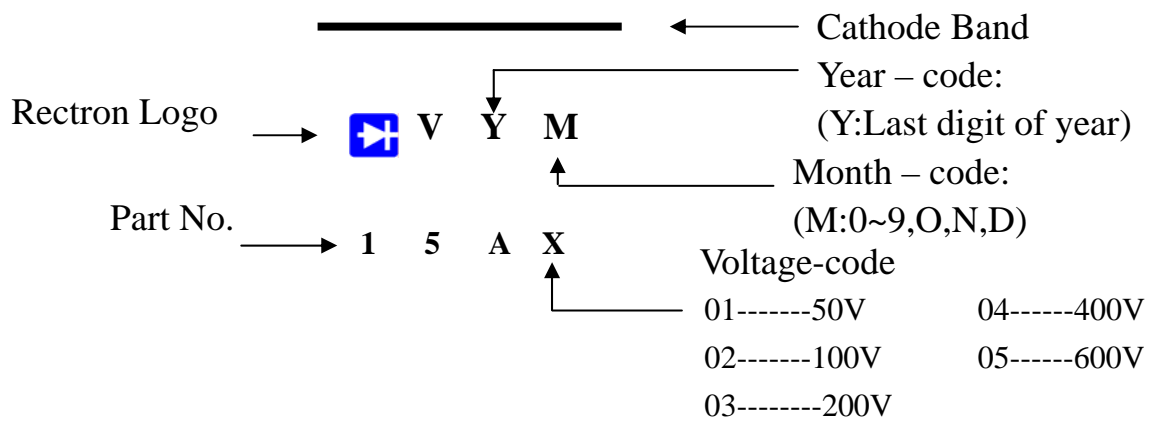

FIG. 5 - TYPICAL THERMAL RESISTANCE VS LEAD LENGTH



Marking Description



DISCLAIMER NOTICE

Rectron Inc reserves the right to make changes without notice to any product specification herein, to make corrections, modifications, enhancements or other changes. Rectron Inc or anyone on its behalf assumes no responsibility or liability for any errors or inaccuracies. Data sheet specifications and its information contained are intended to provide a product description only. "Typical" parameters which may be included on RECTRON data sheets and/ or specifications can and do vary in different applications and actual performance may vary over time. Rectron Inc does not assume any liability arising out of the application or use of any product or circuit.

Rectron products are not designed, intended or authorized for use in medical, life-saving implant or other applications intended for life-sustaining or other related applications where a failure or malfunction of component or circuitry may directly or indirectly cause injury or threaten a life without expressed written approval of Rectron Inc. Customers using or selling Rectron components for use in such applications do so at their own risk and shall agree to fully indemnify Rectron Inc and its subsidiaries harmless against all claims, damages and expenditures.