



SCHOTTKY BARRIER RECTIFIER
VOLTAGE 30 Volts CURRENT 10 Ampere

FEATURES

- * High reliability
- * Low switching loss
- * Low forward voltage drop
- * High current capability
- * High switching capability

MECHANICAL DATA

- * Epoxy: Device has UL flammability classification 94V-O
- * Case: Molded plastic
- * Lead: MIL-STD-202E method 208C guaranteed
- * Mounting: position: Any
- * Weight: 0.33 grams

MAXIMUM RATINGS AND ELECTRICAL CHARACTERISTICS

Ratings at 25 °C ambient temperature unless otherwise specified.
resistive or inductive load.

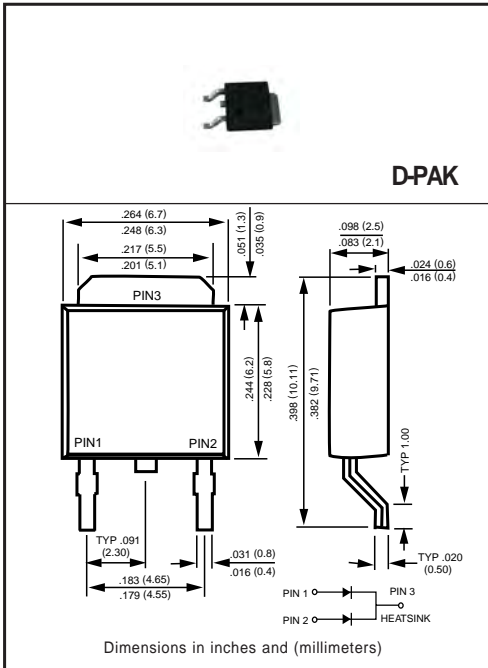

MAXIMUM RATINGS (@ TA=25 °C unless otherwise noted)

RATINGS	SYMBOL	SR1030CK	UNITS
Maximum Recurrent Peak Reverse Voltage	V_{RRM}	30	Volts
Maximum RMS Voltage	V_{RMS}	21	Volts
Maximum DC Blocking Voltage	V_{DC}	30	Volts
Maximum Average Forward Rectified Current at Derating Case Temperature	I_O	10	Amps
Peak Forward Surge Current 8.3 ms single half sine-wave superimposed on rated load (JEDEC method)	I_{FSM}	150	Amps
Typical Current Squared Time	i^2T	93.3	A ² S
Typical Thermal Resistance (Note 1)	$R_{\theta JA}$	60	°C/W
	$R_{\theta JC}$	3	
Typical Junction Capacitance (Note 2)	C_J	200	pF
Operating Temperature Range	T_J	150	°C
Storage Temperature Range	T_{STG}	-55 to + 150	°C

ELECTRICAL CHARACTERISTICS (@TA=25 °C unless otherwise noted)

CHARACTERISTICS	SYMBOL	SR1030CK	UNITS	
Maximum Instantaneous Forward Voltage at 5.0A DC	V_F	.85	Volts	
Maximum Average Reverse Current at Rated DC Blocking Voltage	I_R	@ $T_A = 25^\circ C$	0.2	mA
		@ $T_A = 100^\circ C$	2	mA

- NOTES :
1. Thermal Resistance : Heat-sink case mounted or if PCB mounted.
 2. Measured at 1 MHz and applied reverse voltage of 4.0 volts.
 3. "Fully ROHS compliant", "100% Sn plating (Pb-free)".
 4. Suffix "R" for Reverse Polarity.
 5. Suffix "S" for D2-PAK Pkg.
 6. Available in Halogen-free epoxy by adding suffix -HF after the part nbr.

RATING AND CHARACTERISTICS CURVES (SR1030CK)

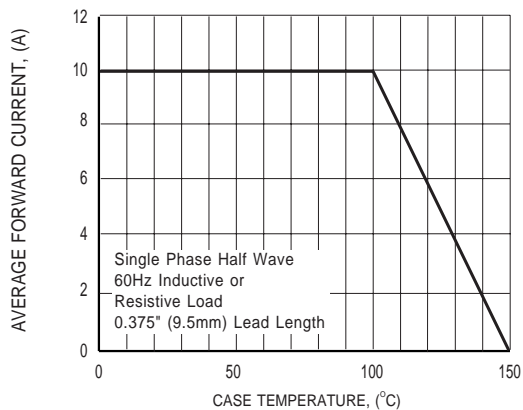

FIG.1 TYPICAL FORWARD CURRENT DERATING CURVE

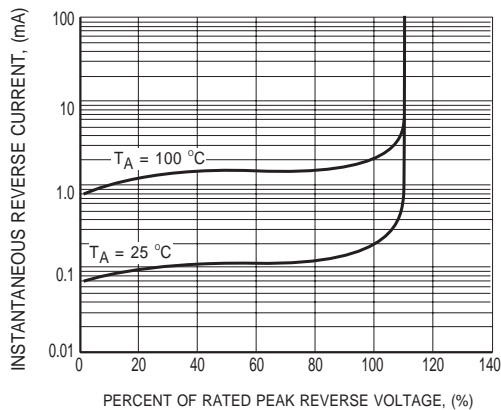

FIG.2 TYPICAL REVERSE CHARACTERISTICS

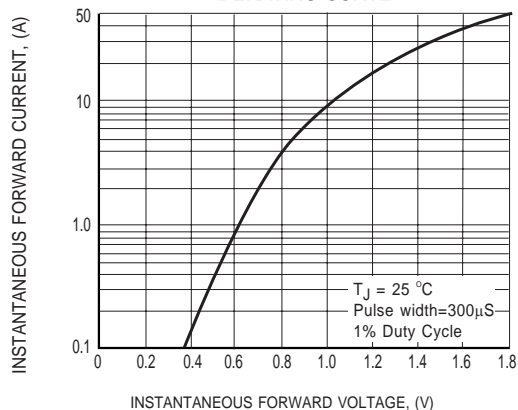

FIG.3 TYPICAL INSTANTANEOUS FORWARD CHARACTERISTICS

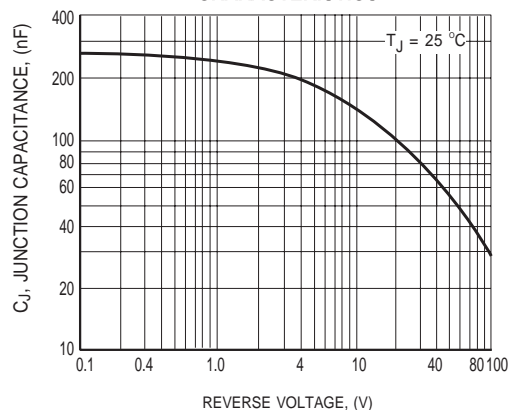

FIG.4 TYPICAL JUNCTION CAPACITANCE

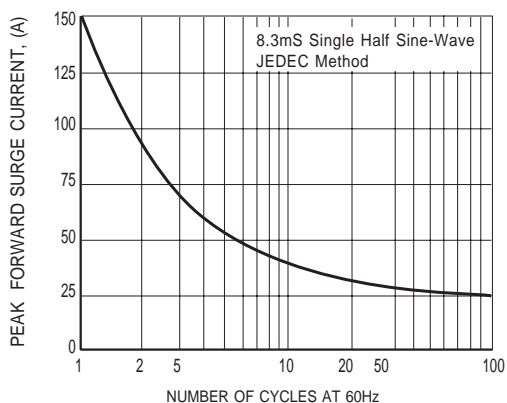
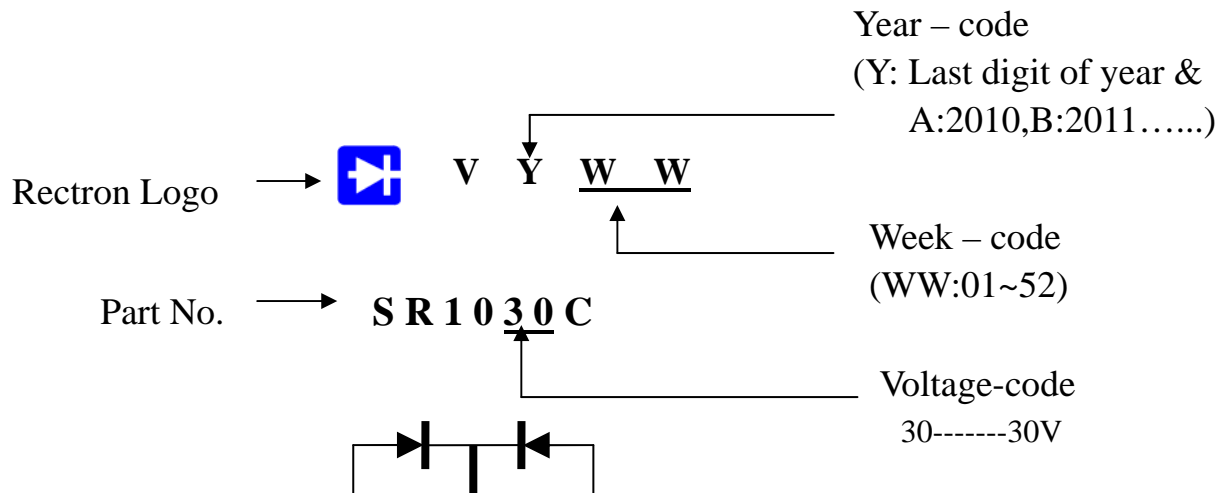

FIG.5 MAXIMUM NON-REPETITIVE FORWARD SURGE CURRENT

Marking Description



DISCLAIMER NOTICE

Rectron Inc reserves the right to make changes without notice to any product specification herein, to make corrections, modifications, enhancements or other changes. Rectron Inc or anyone on its behalf assumes no responsibility or liability for any errors or inaccuracies. Data sheet specifications and its information contained are intended to provide a product description only. "Typical" parameters which may be included on RECTRON data sheets and/ or specifications can and do vary in different applications and actual performance may vary over time. Rectron Inc does not assume any liability arising out of the application or use of any product or circuit.

Rectron products are not designed, intended or authorized for use in medical, life-saving implant or other applications intended for life-sustaining or other related applications where a failure or malfunction of component or circuitry may directly or indirectly cause injury or threaten a life without expressed written approval of Rectron Inc. Customers using or selling Rectron components for use in such applications do so at their own risk and shall agree to fully indemnify Rectron Inc and its subsidiaries harmless against all claims, damages and expenditures.