

SURFACE MOUNT SUPER FAST RECTIFIER

VOLTAGE RANGE 50 to 400 Volts CURRENT 0.5 Ampere

FEATURES

- * High reliability
- * Low leakage
- * Low forward voltage
- * High current capability
- * Super fast switching speed
- * High surge capability
- * Good for switching mode circuit

MECHANICAL DATA

- * Case: Molded plastic
- * Epoxy: Device has UL flammability classification 94V-O
- * Lead: MIL-STD-202E method 208C guaranteed
- * Mounting position: Any
- * Weight: 0.015 gram

MAXIMUM RATINGS AND ELECTRICAL CHARACTERISTICS

Ratings at 25 °C ambient temperature unless otherwise specified.
Resistive or inductive load.



SOD-123FL

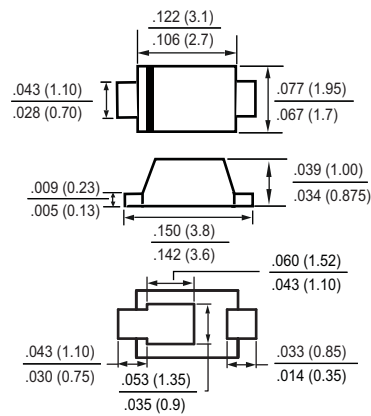

Dimensions in inches and (millimeters)

MAXIMUM RATINGS (@ TA=25 °C unless otherwise noted)

RATINGS	SYMBOL	05E1L	05E2L	05E3L	05E4L	05E5L	05E6L	UNITS
Maximum Recurrent Peak Reverse Voltage	V _{RRM}	50	100	150	200	300	400	Volts
Maximum RMS Voltage	V _{RMS}	35	70	105	140	210	280	Volts
Maximum DC Blocking Voltage	V _{DC}	50	100	150	200	300	400	Volts
Maximum Average Forward Rectified Current at T _A = 55°C	I _O	0.5						Amps
Peak Forward Surge Current 8.3 ms single half sine-wave superimposed on rated load (JEDEC method)	I _{FSM}	15						Amps
Typical Current Square Time	I ² T	0.9						A ² S
Typical Thermal Resistance (Note 1)	R _{θJA}	130						°C/W
Typical Thermal Resistance (Note 1)	R _{θJL}	30						°C/W
Typical Junction Capacitance (Note 2)	C _J	15				10		pF
Operating Temperature Range	T _J	-55 to + 150						°C
Storage Temperature Range	T _{STG}	-55 to + 150						°C

ELECTRICAL CHARACTERISTICS (@TA=25 °C unless otherwise noted)

CHARACTERISTICS	SYMBOL	05E1L	05E2L	05E3L	05E4L	05E5L	05E6L	UNITS
Maximum Instantaneous Forward Voltage at 0.5A DC	V _F	0.95				1.25		Volts
Maximum Average Reverse Current @ T _A = 25°C	I _R	5						μA
at Rated DC Blocking Voltage @ T _A = 150°C		20						mA
Maximum Reverse Recovery Time (Note 4)	t _{rr}	35						nSec

- NOTES : 1. Thermal Resistance :Mounted on PCB.
 2. Measured at 1 MHz and applied reverse voltage of 4.0 volts.
 3. "ROHS compliant".
 4. Test Conditions: I_F = 0.5A, I_R = -1.0A, I_{RR} = -0.25A.

RATING AND CHARACTERISTICS CURVES (05E1L THRU 05E6L)

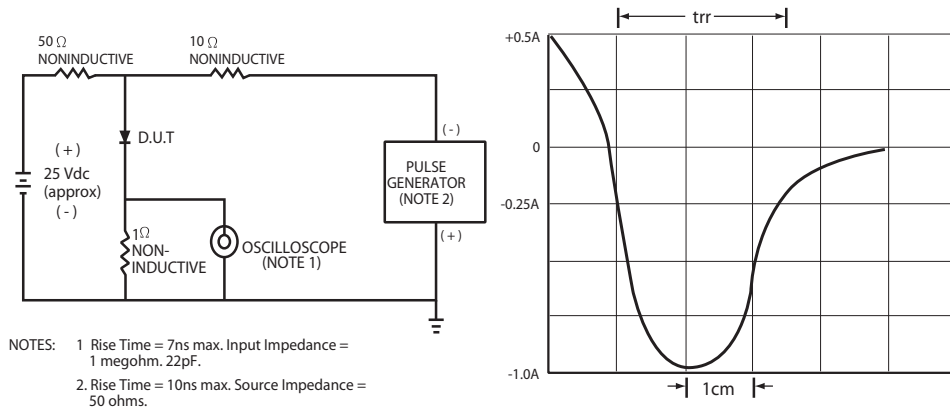

FIG.1 TEST CIRCUIT DIAGRAM AND REVERSE RECOVERY TIME CHARACTERISTIC

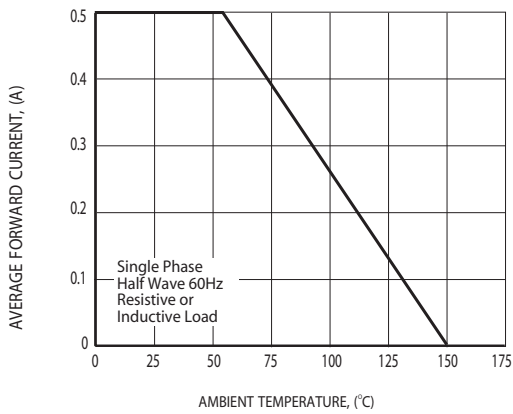

FIG.2 TYPICAL FORWARD CURRENT DERATING CURVE

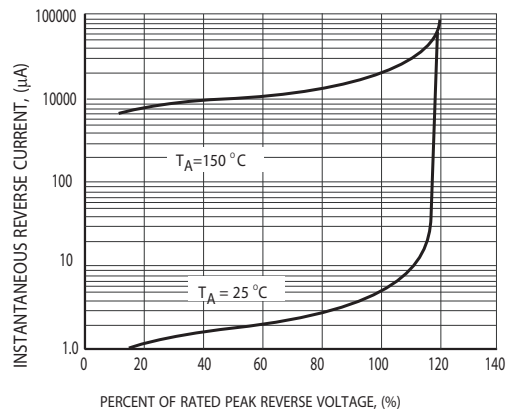

FIG.3 MAXIMUM REVERSE CHARACTERISTICS

RATING AND CHARACTERISTICS CURVES (05E1L THRU 05E6L)

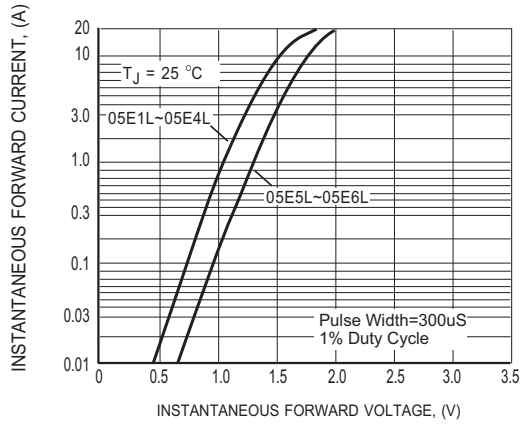

FIG.4 MAXIMUM INSTANTANEOUS FORWARD CHARACTERISTICS

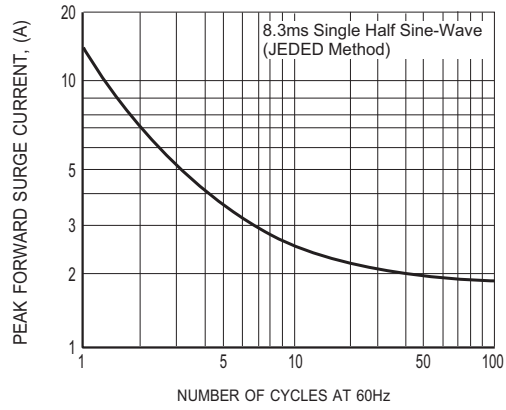

FIG.5 MAXIMUM NON-REPETITIVE FORWARD SURGE CURRENT

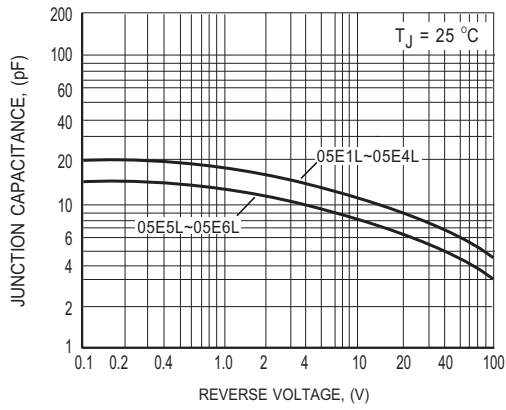
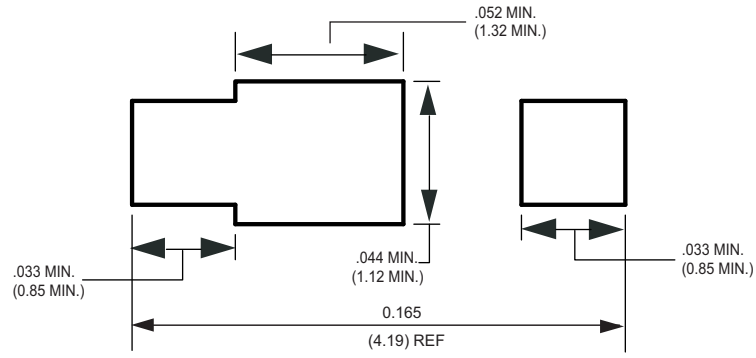

FIG.6 TYPICAL JUNCTION CAPACITANCE

Mounting Pad Layout



Dimensions in inches and (millimeters)

Marking Description

Year- code ← **X**
(Last digit of year)

Voltage-code: ← **M**
A week 01~02
B week 03~04
C week 05~06
.....
Z week 51~52

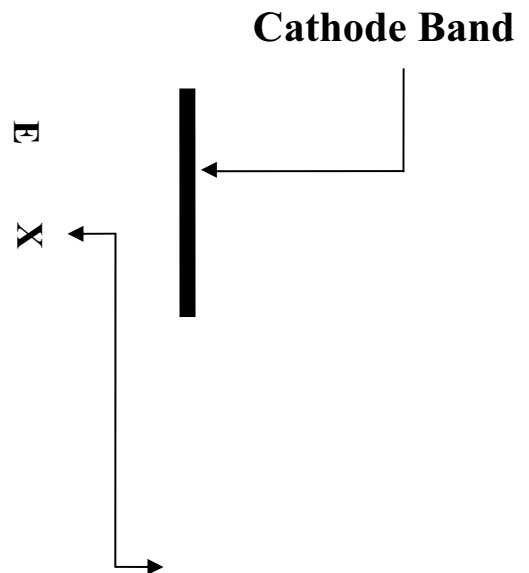

Voltage code	
1-----	50V
2-----	100V
3-----	150V
4-----	200V
5-----	300V
6-----	400V

PACKAGING OF DIODE AND BRIDGE RECTIFIERS

REEL PACK

PACKAGE	PACKING CODE	EA PER REEL	EA PER INNER BOX	COMPONENT SPACE (mm)	TAPE SPACE (mm)	REEL DIA (mm)	CARTON SIZE (mm)	EA PER CARTON	GROSS WEIGHT(Kg)
SOD-123F/ SOD-123FL	-W	3,000	15,000	---	---	178	390*205*31	120,000	6.964

DISCLAIMER NOTICE

Rectron Inc reserves the right to make changes without notice to any product specification herein, to make corrections, modifications, enhancements or other changes. Rectron Inc or anyone on its behalf assumes no responsibility or liability for any errors or inaccuracies. Data sheet specifications and its information contained are intended to provide a product description only. "Typical" parameters which may be included on RECTRON data sheets and/ or specifications can and do vary in different applications and actual performance may vary over time. Rectron Inc does not assume any liability arising out of the application or use of any product or circuit.

Rectron products are not designed, intended or authorized for use in medical, life-saving implant or other applications intended for life-sustaining or other related applications where a failure or malfunction of component or circuitry may directly or indirectly cause injury or threaten a life without expressed written approval of Rectron Inc. Customers using or selling Rectron components for use in such applications do so at their own risk and shall agree to fully indemnify Rectron Inc and its subsidiaries harmless against all claims, damages and expenditures.