

**FAST RECOVERY GLASS PASSIVATED RECTIFIER**

**VOLTAGE RANGE 50 to 600 Volts CURRENT 1.0 Ampere**

**FEATURES**

- \* High reliability
- \* Low leakage
- \* Low forward voltage drop
- \* Glass passivated junction
- \* High switch capability

**MECHANICAL DATA**

- \* Case: Molded plastic
- \* Epoxy: Device has UL flammability classification 94V-0
- \* Lead: MIL-STD-202E method 208C guaranteed
- \* Mounting position: Any
- \* Weight: 0.35 gram

**MAXIMUM RATINGS AND ELECTRICAL CHARACTERISTICS**

Ratings at 25 °C ambient temperature unless otherwise specified.  
 Single phase, half wave, 60 Hz, resistive or inductive load.  
 For capacitive load, derate current by 20%.

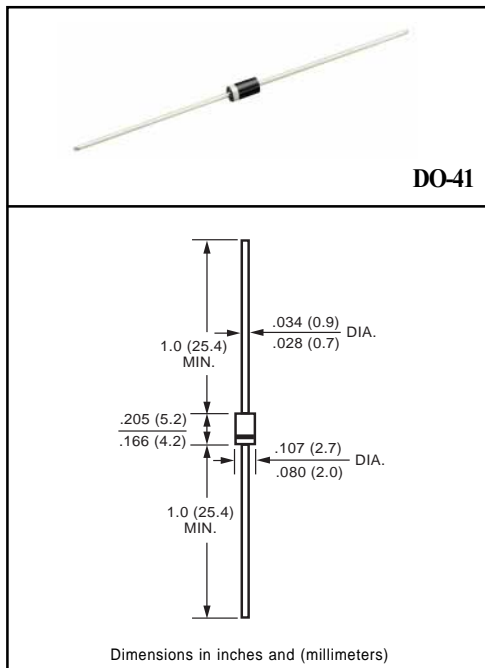

**MAXIMUM RATINGS** (At TA = 25°C unless otherwise noted)

RATINGS	SYMBOL	1N4933G	1N4934G	1N4935G	1N4936G	1N4937G	UNITS
Maximum Recurrent Peak Reverse Voltage	VRRM	50	100	200	400	600	Volts
Maximum RMS Voltage	VRMS	35	70	140	280	420	Volts
Maximum DC Blocking Voltage	VDC	50	100	200	400	600	Volts
Maximum Average Forward Rectified Current at TA = 55°C	IO	1.0					Amps
Peak Forward Surge Current 8.3 ms single half sine-wave superimposed on rated load (JEDEC method)	IFSM	30					Amps
Typical Junction Capacitance (Note 2)	CJ	15					pF
Operating and Storage Temperature Range	TJ, TSTG	-55 to + 150					°C

**ELECTRICAL CHARACTERISTICS** (At TA = 25°C unless otherwise noted)

CHARACTERISTICS	SYMBOL	1N4933G	1N4934G	1N4935G	1N4936G	1N4937G	UNITS
Maximum Instantaneous Forward Voltage at 1.0A DC	VF	1.2					Volts
Maximum DC Reverse Current at Rated DC Blocking Voltage TA = 25°C	IR	5.0					uAmps
Maximum Full Load Reverse Current Full Cycle Average, .375" (9.5mm) lead length at TL = 55°C		100					uAmps
Maximum Reverse Recovery Time (Note 1)	ttr	200					nSec

NOTES : 1. Test Conditions: IF = 1.0A, VR = 30V  
 2. Measured at 1 MHz and applied reverse voltage of 4.0 volts

# RATING AND CHARACTERISTIC CURVES ( 1N4933G THRU 1N4937G )

FIG. 1 - TYPICAL FORWARD CURRENT DERATING CURVE

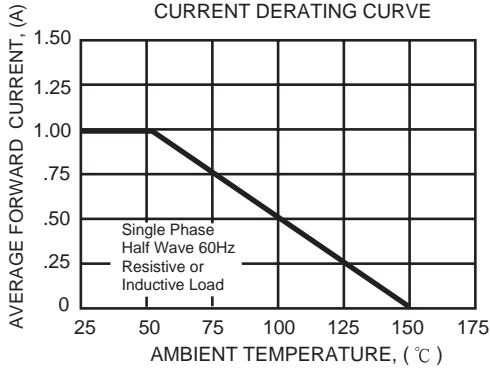

FIG. 2 - MAXIMUM NON-REPETITIVE FORWARD SURGE CURRENT

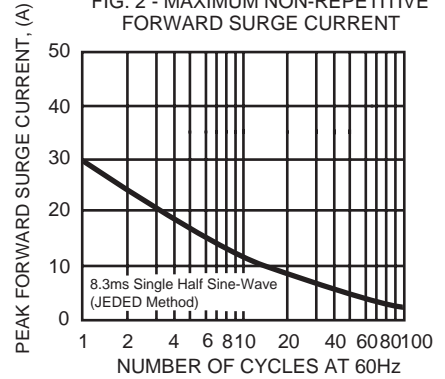

FIG. 3 - TYPICAL JUNCTION CAPACITANCE

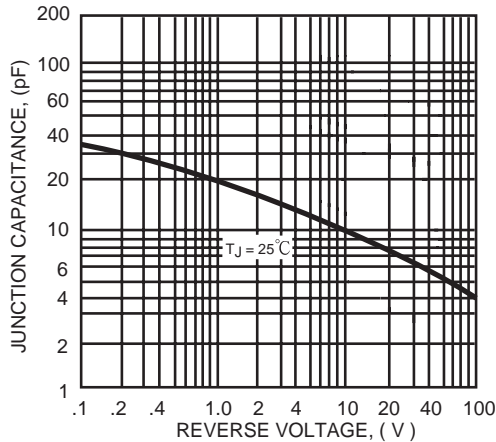

FIG. 4 - TYPICAL INSTANTANEOUS FORWARD CHARACTERISTICS

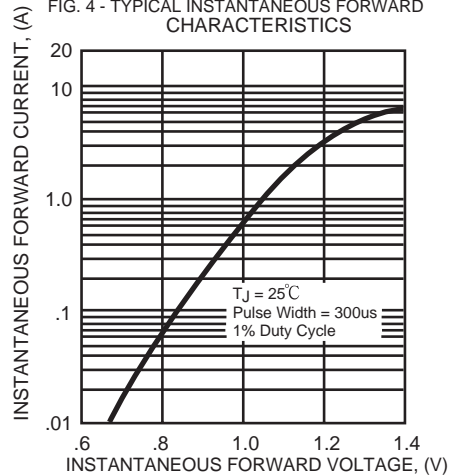

FIG. 5 - TEST CIRCUIT DIAGRAM AND REVERSE RECOVERY TIME CHARACTERISTIC

