

N-Channel Enhancement Mode Power MOSFET

General Features

- $V_{DS} = 60V, I_D = 0.115A$
 $R_{DS(ON)} < 3\Omega @ V_{GS}=5V$
 $R_{DS(ON)} < 2\Omega @ V_{GS}=10V$

- Lead free product is acquired
- Surface mount package

Application

- Direct logic-level interface: TTL/CMOS
- Drivers: relays, solenoids, lamps, hammers, display, memories, transistors, etc.
- Battery operated systems
- Solid-state relays
- P/N suffix V means AEC-Q101 qualified, e.g:2N7002V
- Halogen-free

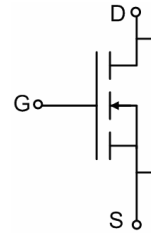

Schematic diagram

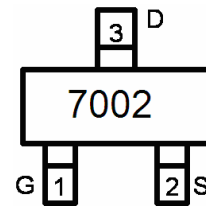

Marking and pin assignment



SOT-23 top view

Package Marking and Ordering Information

Device Marking	Device	Device Package	Reel Size	Tape width	Quantity
7002	2N7002	SOT-23	Ø180mm	8 mm	3000 units

Absolute Maximum Ratings (TC=25°C unless otherwise noted)

Parameter	Symbol	Limit	Unit
Drain-Source Voltage	V_{DS}	60	V
Gate-Source Voltage	V_{GS}	±20	V
Drain Current-Continuous@ Current-Pulsed ^(Note 1)	I_D	0.115	A
	I_{DM}	0.8	A
Maximum Power Dissipation	P_D	0.2	W
Operating Junction and Storage Temperature Range	T_J, T_{STG}	-55 To 150	°C

Thermal Characteristic

Thermal Resistance, Junction-to-Ambient ^(Note 2)	$R_{\theta JA}$	625	°C/W
---	-----------------	-----	------

Electrical Characteristics (TC=25°C unless otherwise noted)

Parameter	Symbol	Condition	Min	Typ	Max	Unit
Off Characteristics						
Drain-Source Breakdown Voltage	BV_{DSS}	$V_{GS}=0V, I_D=250\mu A$	60	68	-	V
Zero Gate Voltage Drain Current	I_{DSS}	$V_{DS}=60V, V_{GS}=0V$	-	-	1	μA

Gate-Body Leakage Current	I_{GSS}	$V_{GS}=\pm 20V, V_{DS}=0V$	-	-	± 100	nA
On Characteristics ^(Note 3)						
Gate Threshold Voltage	$V_{GS(th)}$	$V_{DS}=V_{GS}, I_D=250\mu A$	1	1.7	2.5	V
Drain-Source On-State Resistance	$R_{DS(ON)}$	$V_{GS}=5V, I_D=0.05A$	-	1.3	3	Ω
		$V_{GS}=10V, I_D=0.5A$	-	1.1	2	Ω
Forward Transconductance	g_{FS}	$V_{DS}=10V, I_D=0.2A$	0.08	-	-	S
Dynamic Characteristics ^(Note4)						
Input Capacitance	C_{iss}	$V_{DS}=30V, V_{GS}=0V,$ $F=1.0MHz$	-	20	50	PF
Output Capacitance	C_{oss}		-	10	20	PF
Reverse Transfer Capacitance	C_{rss}		-	3.6	5	PF
Switching Characteristics ^(Note 4)						
Turn-on Delay Time	$t_{d(on)}$	$V_{DD}=30V, I_D=0.2A$ $V_{GS}=10V, R_{GEN}=10\Omega$	-	10	-	nS
Turn-on Rise Time	t_r		-	50	-	nS
Turn-Off Delay Time	$t_{d(off)}$		-	17	-	nS
Turn-Off Fall Time	t_f		-	10	-	nS
Total Gate Charge	Q_g	$V_{DS}=10V, I_D=0.115A,$ $V_{GS}=4.5V$	-	1.7	3	nC
Drain-Source Diode Characteristics						
Diode Forward Voltage ^(Note 3)	V_{SD}	$V_{GS}=0V, I_S=0.115A$	-	-	1.2	V
Diode Forward Current ^(Note 2)	I_S		-	-	0.115	A

Notes:

1. Repetitive Rating: Pulse width limited by maximum junction temperature.
2. Surface Mounted on FR4 Board, $t \leq 10$ sec.
3. Pulse Test: Pulse Width $\leq 300\mu s$, Duty Cycle $\leq 2\%$.
4. Guaranteed by design, not subject to production

RATING AND CHARACTERISTICS CURVES (2N7002V)

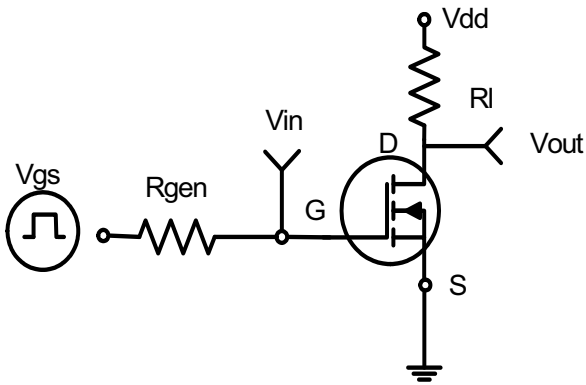

Figure 1: Switching Test Circuit

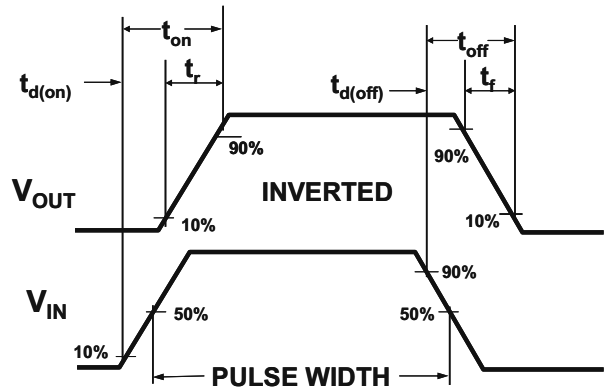

Figure 2: Switching Waveforms

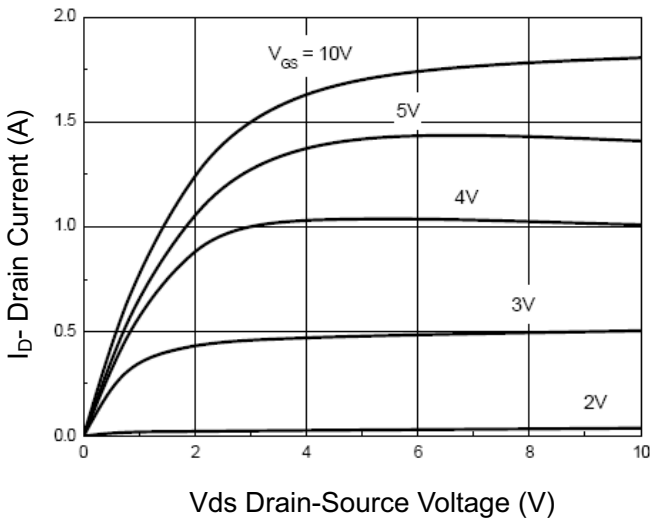

Figure 3 Output Characteristics

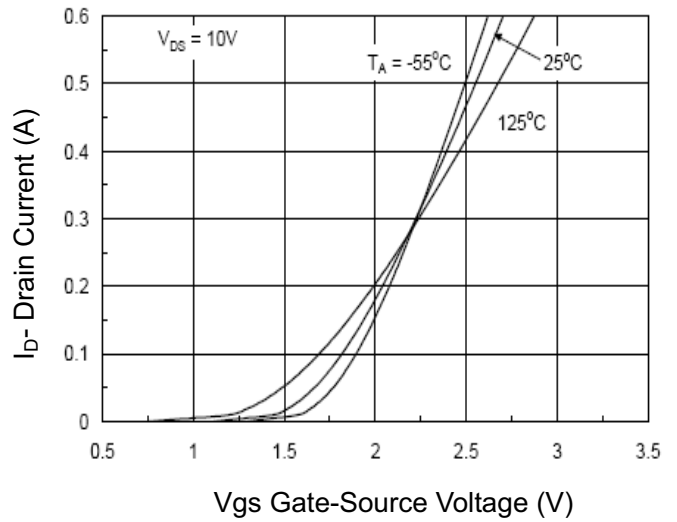

Figure 4 Transfer Characteristics

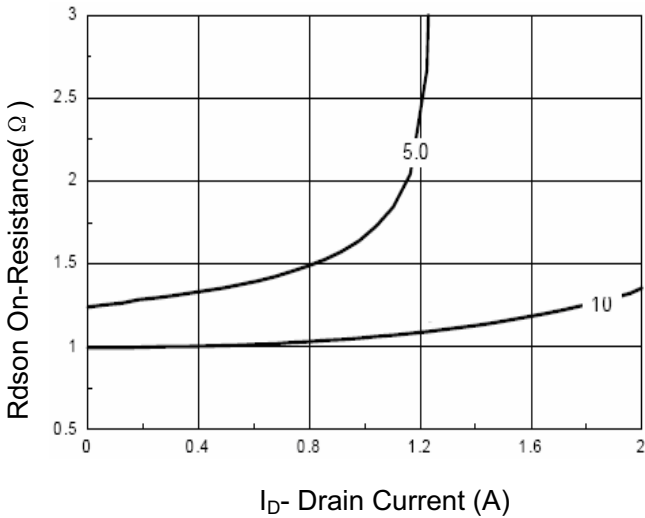

Figure 5 Drain-Source On-Resistance

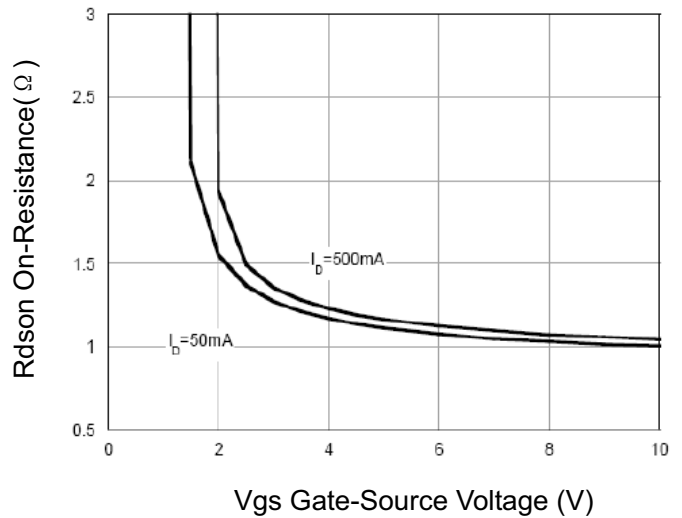

Figure 6 Rdson vs Vgs

RATING AND CHARACTERISTICS CURVES (2N7002V)

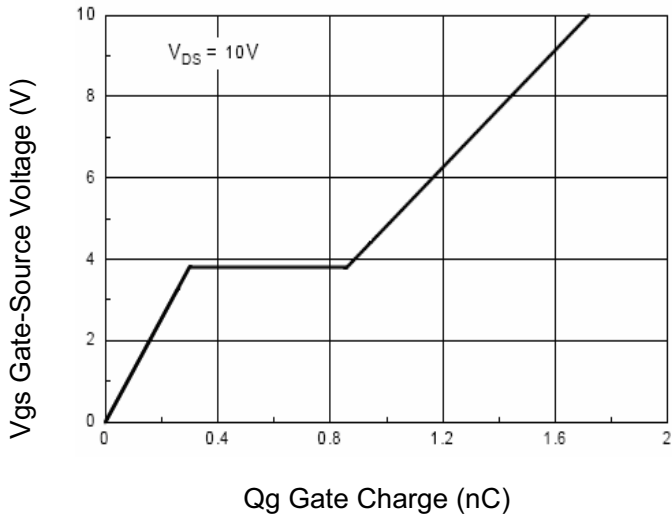

Figure 7 Gate Charge

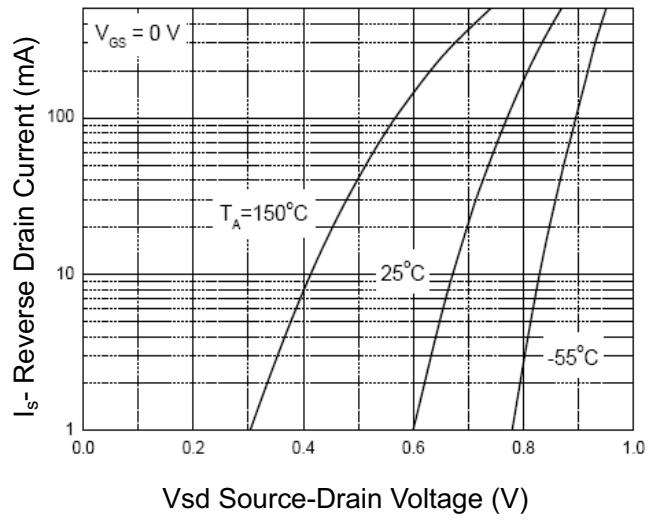

Figure 8 Source-Drain Diode Forward

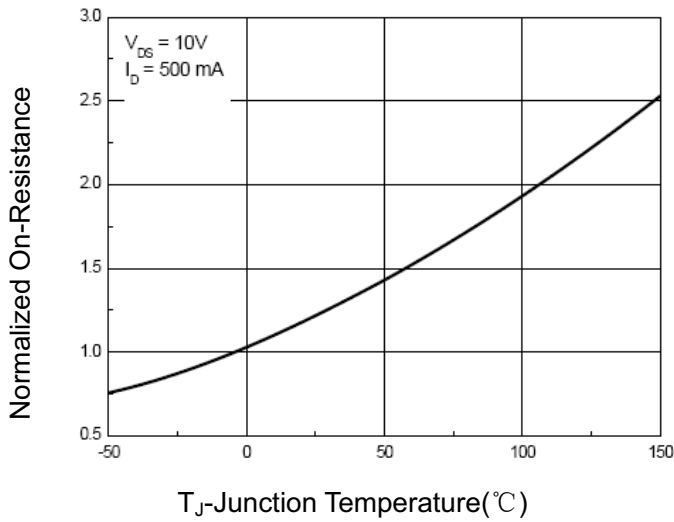

Figure 9 Drain-Source On-Resistance

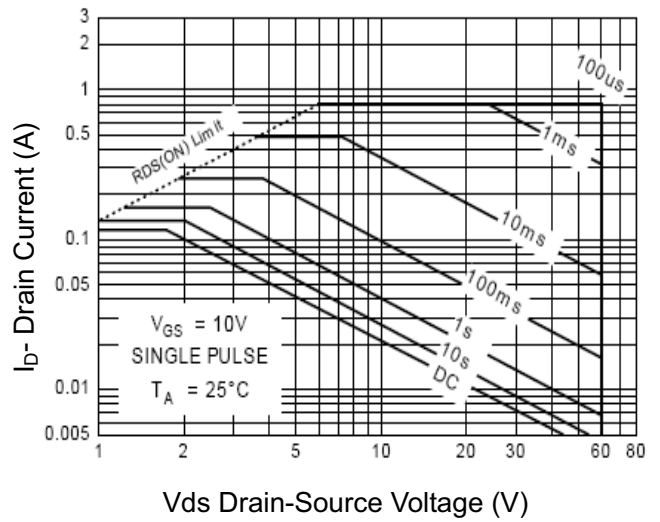

Figure 10 Safe Operation Area

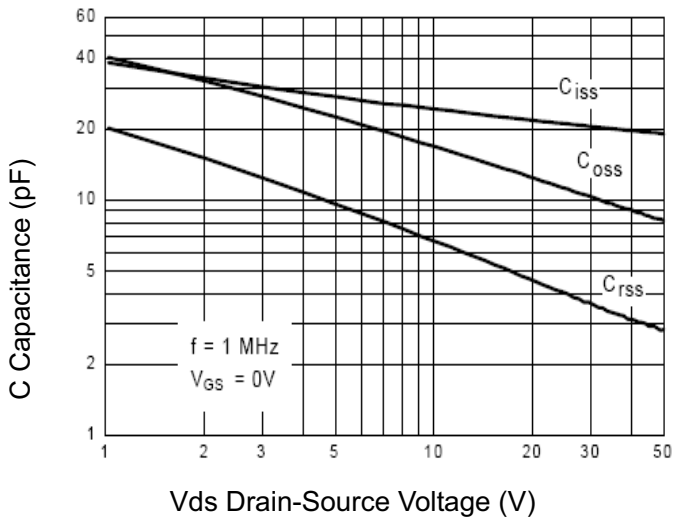

Figure 11 Capacitance vs Vds

RATING AND CHARACTERISTICS CURVES (2N7002V)

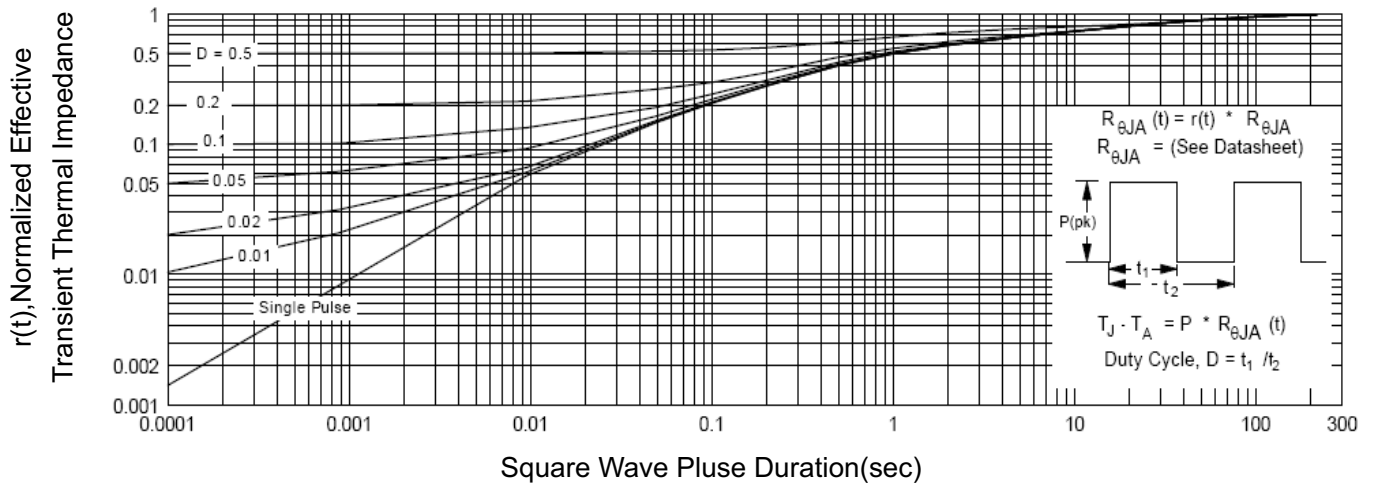
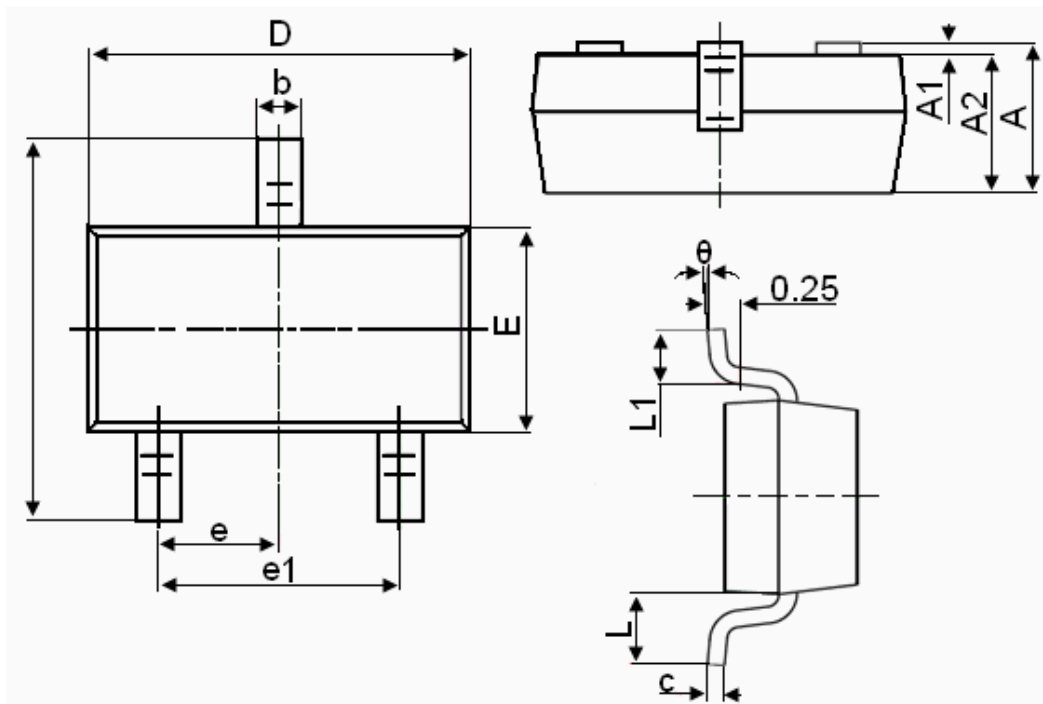

Figure 12 Normalized Maximum Transient Thermal Impedance

SOT-23 Package Information



Symbol	Dimensions in Millimeters	
	MIN.	MAX.
A	0.900	1.150
A1	0.000	0.100
A2	0.900	1.050
b	0.300	0.500
c	0.080	0.150
D	2.800	3.000
E	1.200	1.400
E1	2.250	2.550
e	0.950TYP	
e1	1.800	2.000
L	0.550REF	
L1	0.300	0.500
θ	0°	8°

Notes

1. All dimensions are in millimeters.
2. Tolerance $\pm 0.10\text{mm}$ (4 mil) unless otherwise specified
3. Package body sizes exclude mold flash and gate burrs. Mold flash at the non-lead sides should be less than 5 mils.
4. Dimension L is measured in gauge plane.
5. Controlling dimension is millimeter, converted inch dimensions are not necessarily exact.

DISCLAIMER NOTICE

Rectron Inc reserves the right to make changes without notice to any product specification herein, to make corrections, modifications, enhancements or other changes. Rectron Inc or anyone on its behalf assumes no responsibility or liability for any errors or inaccuracies. Data sheet specifications and its information contained are intended to provide a product description only. "Typical" parameters which may be included on RECTRON data sheets and/ or specifications can and do vary in different applications and actual performance may vary over time. Rectron Inc does not assume any liability arising out of the application or use of any product or circuit.

Rectron products are not designed, intended or authorized for use in medical, life-saving implant or other applications intended for life-sustaining or other related applications where a failure or malfunction of component or circuitry may directly or indirectly cause injury or threaten a life without expressed written approval of Rectron Inc. Customers using or selling Rectron components for use in such applications do so at their own risk and shall agree to fully indemnify Rectron Inc and its subsidiaries harmless against all claims, damages and expenditures.