

Small Signal Transistors (PNP)

FEATURES

- ◆ PNP Silicon Epitaxial Planar Transistors for switching, AF driver and amplifier applications.
- ◆ Especially suited for automatic insertion in thick- and thin-film circuits.
- ◆ These transistors are subdivided into three groups -16, -25 and -40 according to their current gain.
- ◆ As complementary types, the NPN transistors BC817 and BC818 are recommended.
- ◆ Halogen-free

MECHANICAL DATA

Case: SOT-23 Plastic Package

Weight: approx. 0.008 g

Marking code

Type	Marking
BC807-16	5A
-25	5B
-40	5C
BC808-16	5E
-25	5F
-40	5G

SOT-23

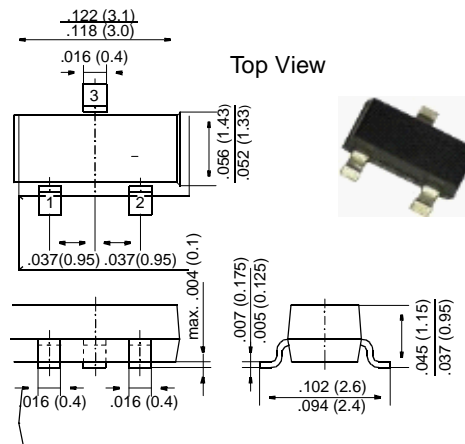

Dimensions in inches and (millimeters)

Pin configuration

1 = Base, 2 = Emitter, 3 = Collector.

MAXIMUM RATINGS AND ELECTRICAL CHARACTERISTICS

Ratings at 25 °C ambient temperature unless otherwise specified

		Symbol	Value	Unit
Collector-Emitter Voltage	BC807	$-V_{CES}$	50	V
	BC808	$-V_{CES}$	30	V
Collector-Emitter Voltage	BC807	$-V_{CEO}$	45	V
	BC808	$-V_{CEO}$	25	V
Emitter-Base Voltage		$-V_{EBO}$	5	V
Collector Current		$-I_C$	500	mA
Peak Collector Current		$-I_{CM}$	1000	mA
Peak Base Current		$-I_{BM}$	200	mA
Peak Emitter Current		I_{EM}	1000	mA
Power Dissipation at $T_{SB} = 50\text{ °C}$		P_{tot}	310 ¹⁾	mW
Junction Temperature		T_j	150	°C
Storage Temperature Range		T_S	-65 to +150	°C

¹⁾ Device on fiberglass substrate, see layout

ELECTRICAL CHARACTERISTICS

Ratings at 25 °C ambient temperature unless otherwise specified

	Symbol	Min.	Typ.	Max.	Unit
DC Current Gain at $-V_{CE} = 1\text{ V}$, $-I_C = 100\text{ mA}$					
Current Gain Group-16	h_{FE}	100	–	250	–
	h_{FE}	160	–	400	–
	h_{FE}	250	–	600	–
at $-V_{CE} = 1\text{ V}$, $-I_C = 300\text{ mA}$	h_{FE}	60	–	–	–
	h_{FE}	100	–	–	–
	h_{FE}	170	–	–	–
Thermal Resistance Junction Substrate Backside	R_{thSB}	–	–	320 ¹⁾	K/W
Thermal Resistance Junction to Ambient Air	R_{thJA}	–	–	450 ¹⁾	K/W
Collector Saturation Voltage at $-I_C = 500\text{ mA}$, $-I_B = 50\text{ mA}$	$-V_{CEsat}$	–	–	0.7	V
Base-Emitter Voltage at $-V_{CE} = 1\text{ V}$, $-I_C = 300\text{ mA}$	$-V_{BE}$	–	–	1.2	V
Collector-Emitter Cutoff Current at $-V_{CE} = 45\text{ V}$ at $-V_{CE} = 25\text{ V}$ at $-V_{CE} = 25\text{ V}$, $T_j = 150\text{ °C}$	BC807 BC808 $-I_{CES}$	–	–	100 100 5	nA nA μA
Emitter-Base Cutoff Current at $-V_{EB} = 4\text{ V}$	$-I_{EBO}$	–	–	100	nA
Gain-Bandwidth Product at $-V_{CE} = 5\text{ V}$, $-I_C = 10\text{ mA}$, $f = 50\text{ MHz}$	f_T	–	100	–	MHz
Collector-Base Capacitance at $-V_{CB} = 10\text{ V}$, $f = 1\text{ MHz}$	C_{CBO}		12		pF
1) Device on fiberglass substrate, see layout					

Layout for R_{thJA} test

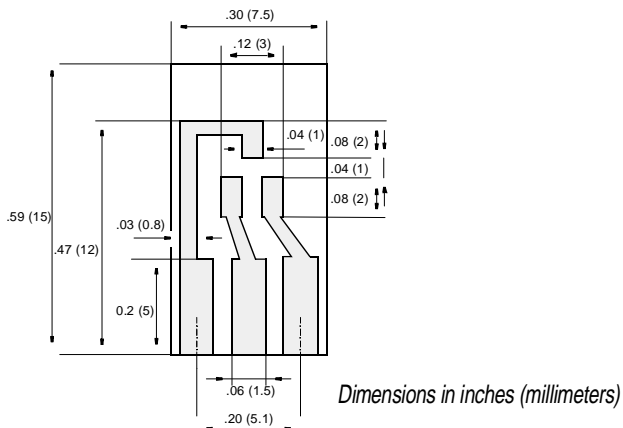

Thickness: Fiberglass 0.059 in (1.5 mm)
Copper leads 0.012 in (0.3 mm)

RATING AND CHARACTERISTICS CURVES (BC807/ BC808)

Admissible power dissipation versus temperature of substrate backside
Device on fiberglass substrate, see layout

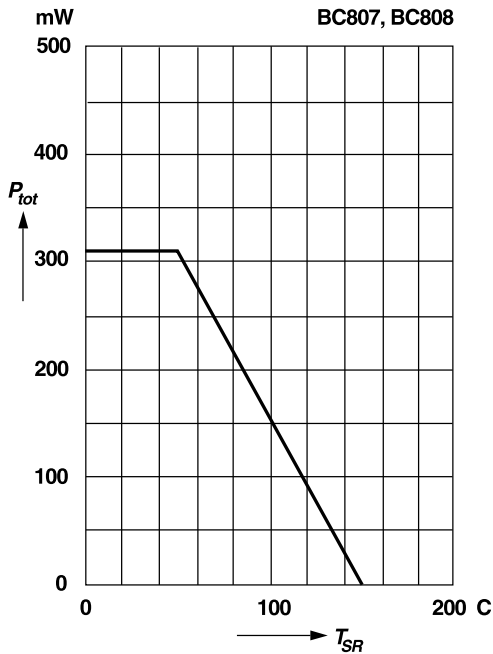

Collector current versus base-emitter voltage

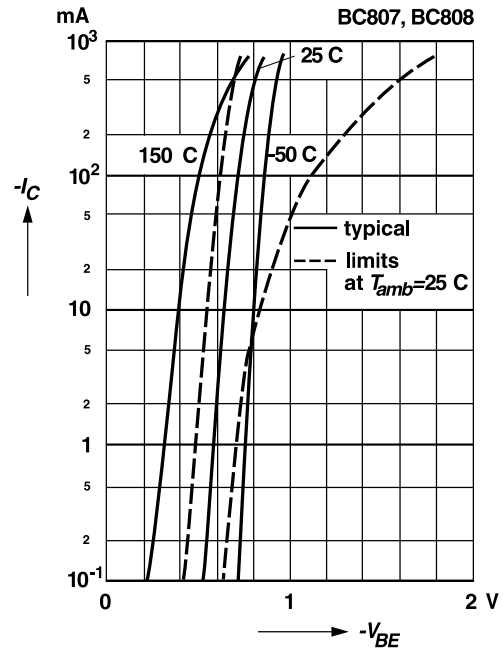

Pulse thermal resistance versus pulse duration (normalized)
Device on fiberglass substrate, see layout

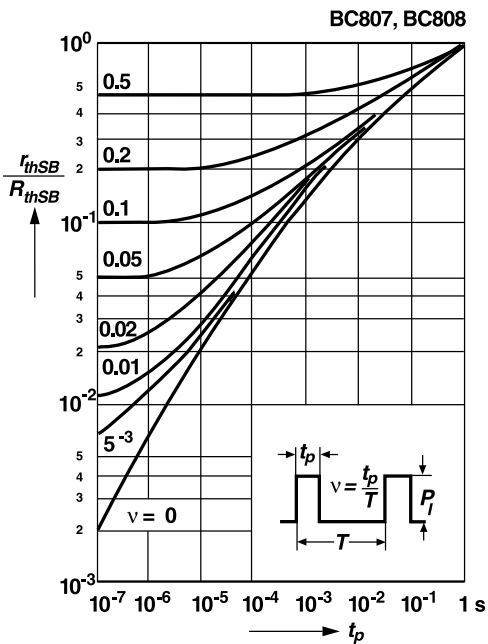

Gain-bandwidth product versus collector current

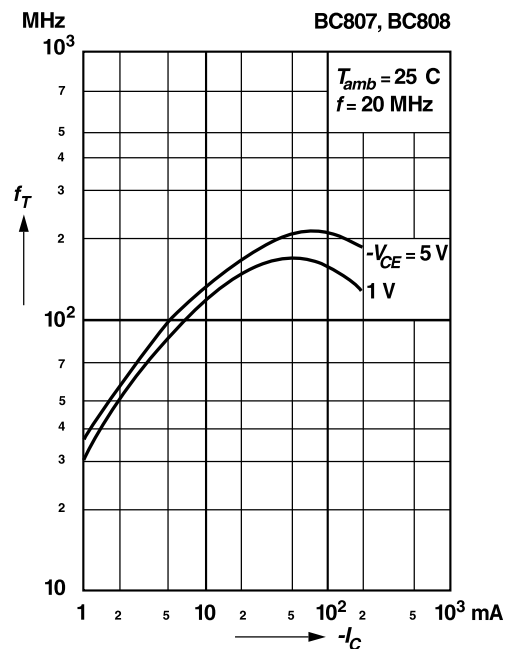

RATING AND CHARACTERISTICS CURVES (BC807/ BC808)

Collector saturation voltage versus collector current

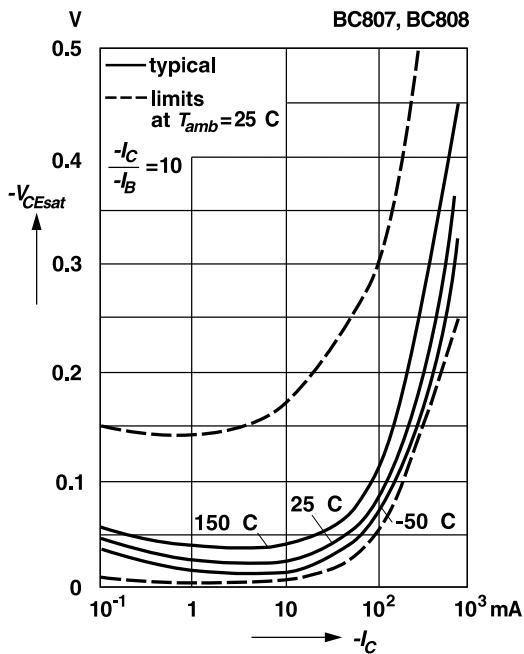

DC current gain versus collector current

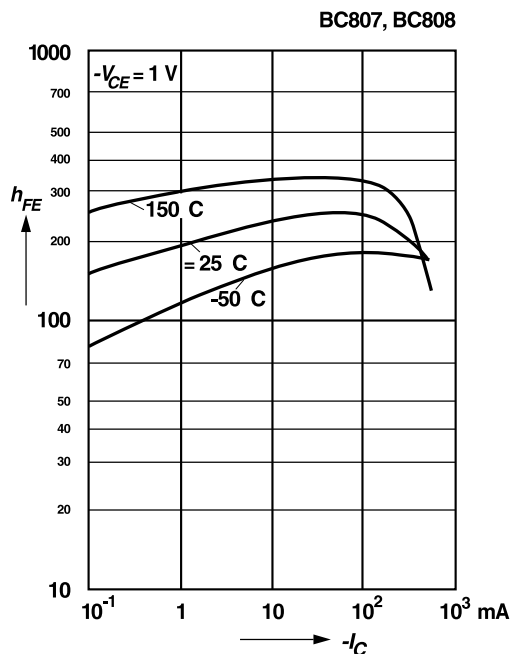

Base saturation voltage versus collector current

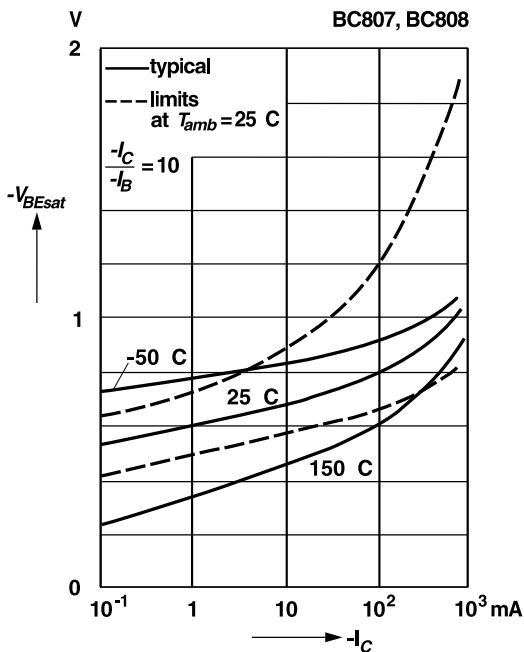

Common emitter collector characteristics

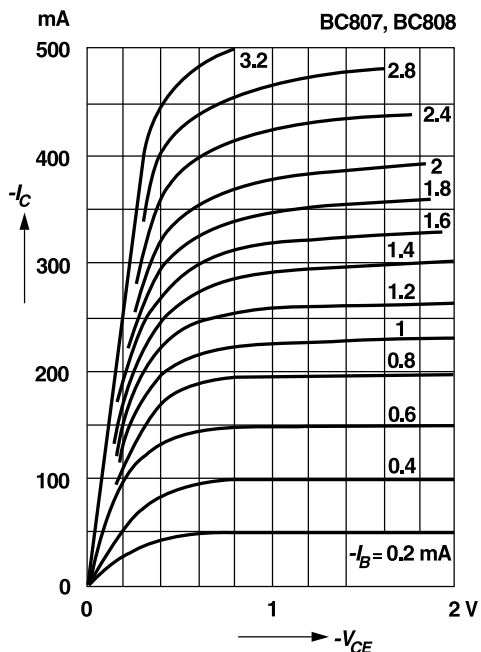

RATING AND CHARACTERISTICS CURVES (BC807/ BC808)

Common emitter
collector characteristics

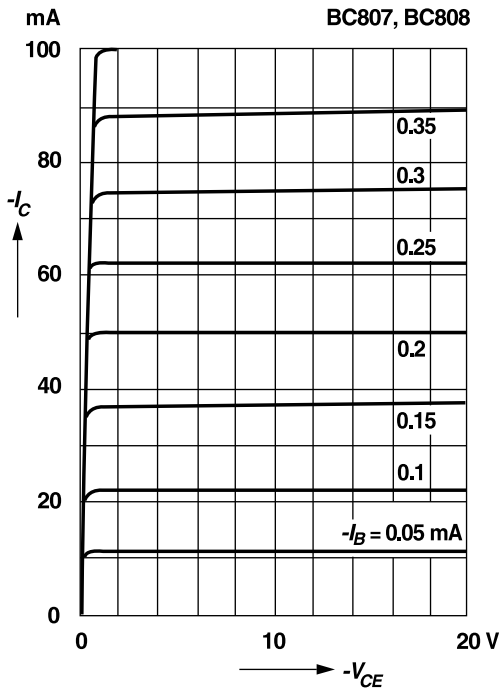

Common emitter
collector characteristics

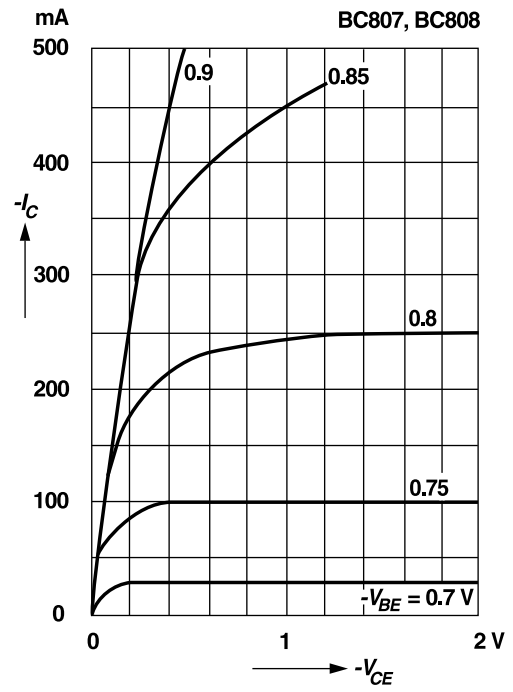

PACKAGING OF DIODE

REEL PACK

PACKAGE	PACKING CODE	REEL (EA)	COMPONENT SPACE(mm)	TAPE SPACE (mm)	REEL DIA (mm)	CARTON SIZE (mm)	EA PER CARTON	GROSS WEIGHT(Kg)
SOT-23/-3L	-T	3,000	---	---	178	438*438*220	180,000	---

DISCLAIMER NOTICE

Rectron Inc reserves the right to make changes without notice to any product specification herein, to make corrections, modifications, enhancements or other changes. Rectron Inc or anyone on its behalf assumes no responsibility or liability for any errors or inaccuracies. Data sheet specifications and its information contained are intended to provide a product description only. "Typical" parameters which may be included on RECTRON data sheets and/ or specifications can and do vary in different applications and actual performance may vary over time. Rectron Inc does not assume any liability arising out of the application or use of any product or circuit.

Rectron products are not designed, intended or authorized for use in medical, life-saving implant or other applications intended for life-sustaining or other related applications where a failure or malfunction of component or circuitry may directly or indirectly cause injury or threaten a life without expressed written approval of Rectron Inc. Customers using or selling Rectron components for use in such applications do so at their own risk and shall agree to fully indemnify Rectron Inc and its subsidiaries harmless against all claims, damages and expenditures.