

**FEATURES**

- Ideally suited for automatic insertion
- For Switching and AF Amplifier Applications

**SOT-23**

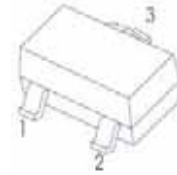

1. BASE  
2. EMITTER  
3. COLLECTOR

**MAXIMUM RATINGS (T<sub>a</sub>=25°C unless otherwise noted)**

Symbol	Parameter	Value	Unit
<b>V<sub>CBO</sub></b>	Collector-Base Voltage		
	BC856	-80	V
	BC857	-50	
BC858	-30		
<b>V<sub>CEO</sub></b>	Collector-Emitter Voltage		
	BC856	-65	V
	BC857	-45	
BC858	-30		
<b>V<sub>EBO</sub></b>	Emitter-Base Voltage	-5	V
<b>I<sub>C</sub></b>	Collector Current –Continuous	-0.1	A
<b>P<sub>C</sub></b>	Collector Power Dissipation	200	mW
<b>R<sub>θJA</sub></b>	Thermal Resistance From Junction To Ambient	625	°C/W
<b>T<sub>J</sub></b>	Junction Temperature	150	°C
<b>T<sub>stg</sub></b>	Storage Temperature	-65~+150	°C

**ELECTRICAL CHARACTERISTICS (T<sub>a</sub>=25°C unless otherwise specified)**

Parameter	Symbol	Test conditions	Min	Max	Unit
Collector-base breakdown voltage	BC856	$I_C = -10\mu A, I_E = 0$	-80		V
	BC857		-50		
	BC858		-30		
Collector-emitter breakdown voltage	BC856	$I_C = -10mA, I_B = 0$	-65		V
	BC857		-45		
	BC858		-30		
Emitter-base breakdown voltage	$V_{EBO}$	$I_E = -1\mu A, I_C = 0$	-5		V
Collector cut-off current	BC856	$V_{CB} = -70V, I_E = 0$			$\mu A$
	BC857		$V_{CB} = -45V, I_E = 0$	-0.1	
	BC858		$V_{CB} = -25V, I_E = 0$		
Collector cut-off current	BC856	$V_{CE} = -60V, I_B = 0$			$\mu A$
	BC857		$V_{CE} = -40V, I_B = 0$	-0.1	
	BC858		$V_{CE} = -25V, I_B = 0$		
Emitter cut-off current	$I_{EBO}$	$V_{EB} = -5V, I_C = 0$		-0.1	$\mu A$
DC current gain	BC856A, 857A, 858A	$V_{CE} = -5V, I_C = -2mA$	125	250	
	BC856B, 857B, 858B		220	475	
	BC857C, BC858C		420	800	
Collector-emitter saturation voltage	$V_{CE(sat)}$	$I_C = -100mA, I_B = -5mA$		-0.5	V
Base-emitter saturation voltage	$V_{BE(sat)}$	$I_C = -100mA, I_B = -5mA$		-1.1	V
Transition frequency	$f_T$	$V_{CE} = -5V, I_C = -10mA$ $f = 100MHz$	100		MHz
Collector capacitance	$C_{ob}$	$V_{CB} = -10V, f = 1MHz$		4.5	pF

**RATING AND CHARACTERISTICS CURVES ( BC856 THRU BC858 )**

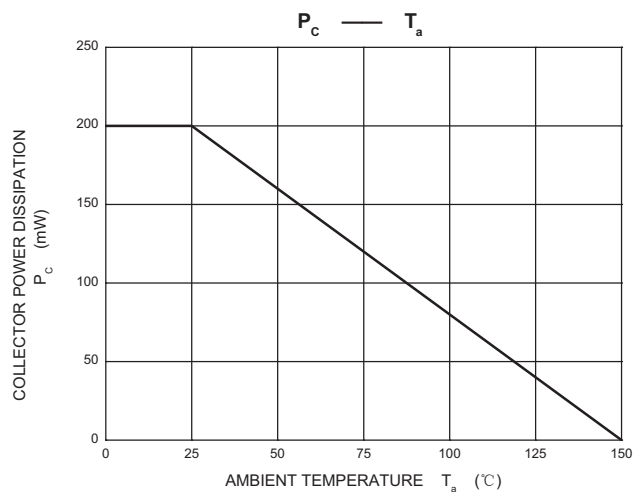
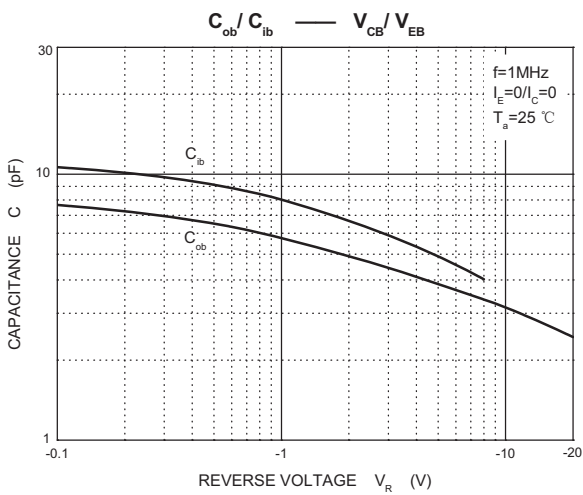

# RATING AND CHARACTERISTICS CURVES ( BC856 THRU BC858 )

**Static Characteristic**

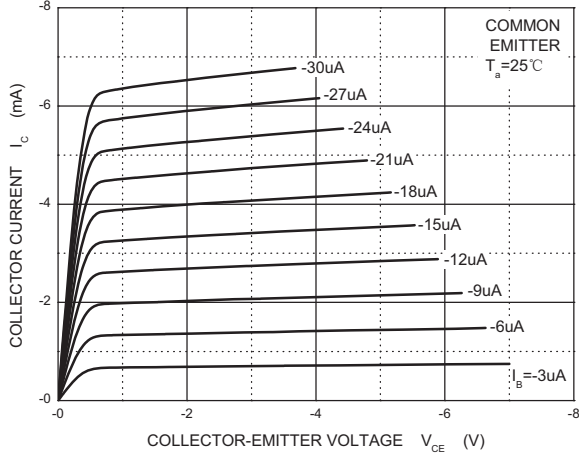

$h_{FE}$  —  $I_c$

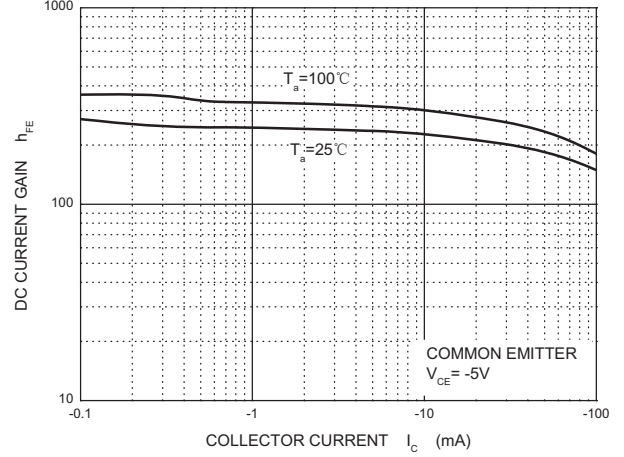

$V_{CEsat}$  —  $I_c$

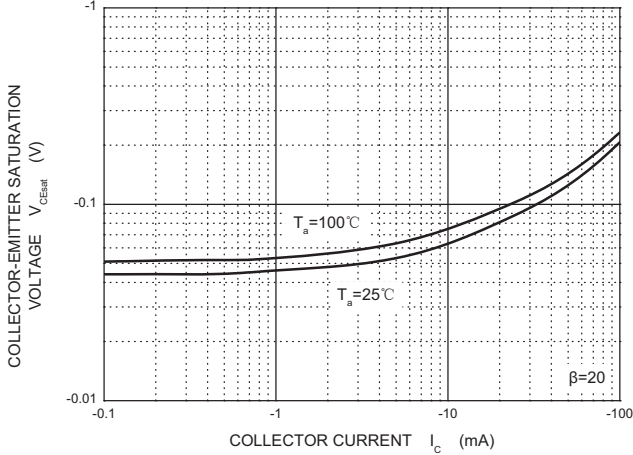

$V_{BEsat}$  —  $I_c$

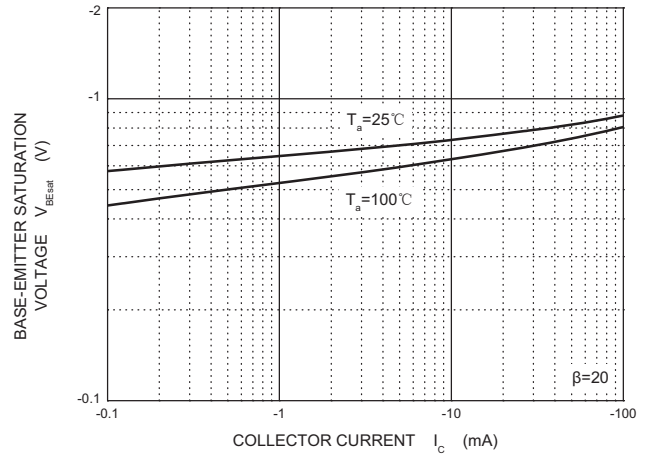

$I_c$  —  $V_{BE}$

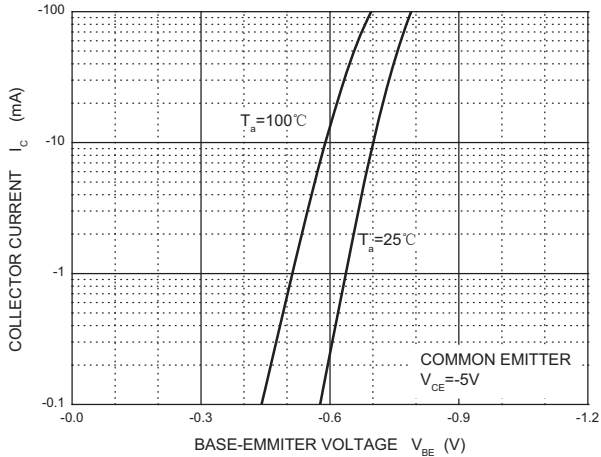

$f_T$  —  $I_c$

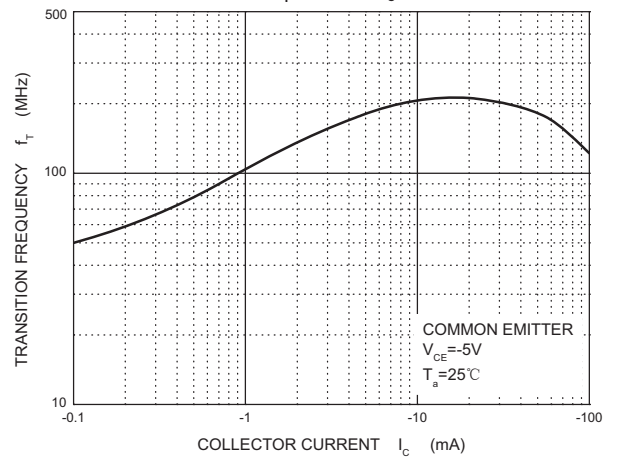

## SOT-23 Package Outline Dimensions

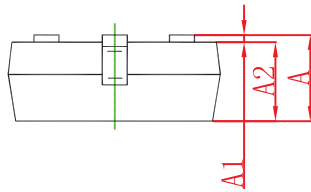
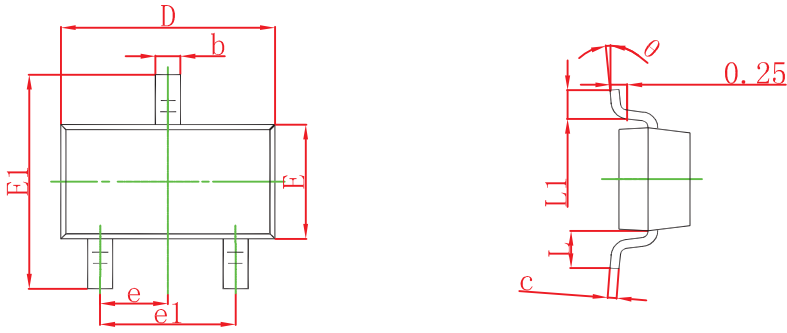

Symbol	Dimensions In Millimeters		Dimensions In Inches	
	Min	Max	Min	Max
A	0.900	1.150	0.035	0.045
A1	0.000	0.100	0.000	0.004
A2	0.900	1.050	0.035	0.041
b	0.300	0.500	0.012	0.020
c	0.080	0.150	0.003	0.006
D	2.800	3.000	0.110	0.118
E	1.200	1.400	0.047	0.055
E1	2.250	2.550	0.089	0.100
e	0.950 TYP		0.037 TYP	
e1	1.800	2.000	0.071	0.079
L	0.550 REF		0.022 REF	
L1	0.300	0.500	0.012	0.020
theta	0°	8°	0°	8°

## SOT-23 Suggested Pad Layout

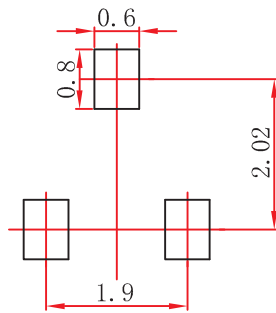

### Note:

1. Controlling dimension: in millimeters.
2. General tolerance:  $\pm 0.05\text{mm}$ .
3. The pad layout is for reference purposes only.

## DEVICE MARKING

BC856A=3A; BC856B=3B;  
 BC857A=3E; BC857B=3F; BC857C=3G;  
 BC858A=3J; BC858B=3K; BC858C=3L

# SOT-23 Tape and Reel

## SOT-23 Embossed Carrier Tape

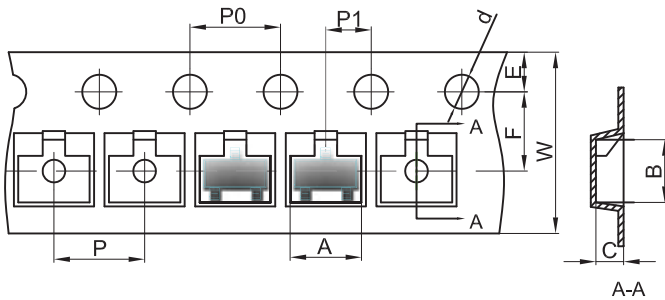

### Packaging Description:

SOT-23 parts are shipped in tape. The carrier tape is made from a dissipative (carbon filled) polycarbonate resin. The cover tape is a multilayer film (Heat Activated Adhesive in nature) primarily composed of polyester film, adhesive layer, sealant, and anti-static sprayed agent. These reeled parts in standard option are shipped with 3,000 units per 7" or 17.8cm diameter reel. The reels are clear in color and is made of polystyrene plastic (anti-static coated).

Dimensions are in millimeter

Pkg type	A	B	C	d	E	F	P0	P	P1	W
SOT-23	3.15	2.77	1.22	Ø1.50	1.75	3.50	4.00	4.00	2.00	8.00

## SOT-23 Tape Leader and Trailer

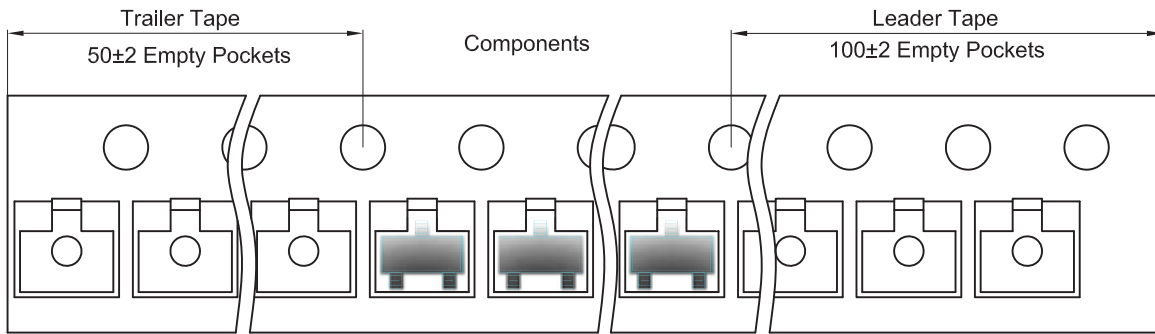

## SOT-23 Reel

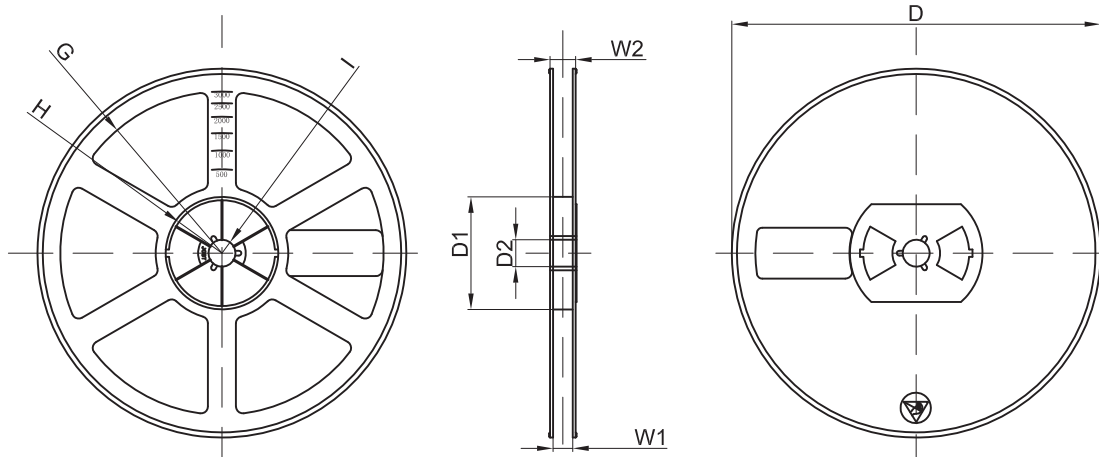

Dimensions are in millimeter

Reel Option	D	D1	D2	G	H	I	W1	W2
7" Dia	Ø178.00	54.40	13.00	R78.00	R25.60	R6.50	9.50	12.30

REEL	Reel Size	Box	Box Size(mm)	Carton	Carton Size(mm)	G.W.(kg)
3000 pcs	7 inch	45,000 pcs	203×203×195	180,000 pcs	438×438×220	

## DISCLAIMER NOTICE

Rectron Inc reserves the right to make changes without notice to any product specification herein, to make corrections, modifications, enhancements or other changes. Rectron Inc or anyone on its behalf assumes no responsibility or liability for any errors or inaccuracies. Data sheet specifications and its information contained are intended to provide a product description only. "Typical" parameters which may be included on RECTRON data sheets and/ or specifications can and do vary in different applications and actual performance may vary over time. Rectron Inc does not assume any liability arising out of the application or use of any product or circuit.

Rectron products are not designed, intended or authorized for use in medical, life-saving implant or other applications intended for life-sustaining or other related applications where a failure or malfunction of component or circuitry may directly or indirectly cause injury or threaten a life without expressed written approval of Rectron Inc. Customers using or selling Rectron components for use in such applications do so at their own risk and shall agree to fully indemnify Rectron Inc and its subsidiaries harmless against all claims, damages and expenditures.