

SURFACE MOUNT
GLASS PASSIVATED SILICON RECTIFIER
VOLTAGE 2000 Volts CURRENT 1.0 Ampere

FEATURES

- * Glass passivated device
- * Ideal for surface mounted applications
- * Low leakage current
- * Metallurgically bonded construction
- * Mounting position: Any

MAXIMUM RATINGS AND ELECTRICAL CHARACTERISTICS

Ratings at 25 °C ambient temperature unless otherwise specified.
resistive or inductive load.

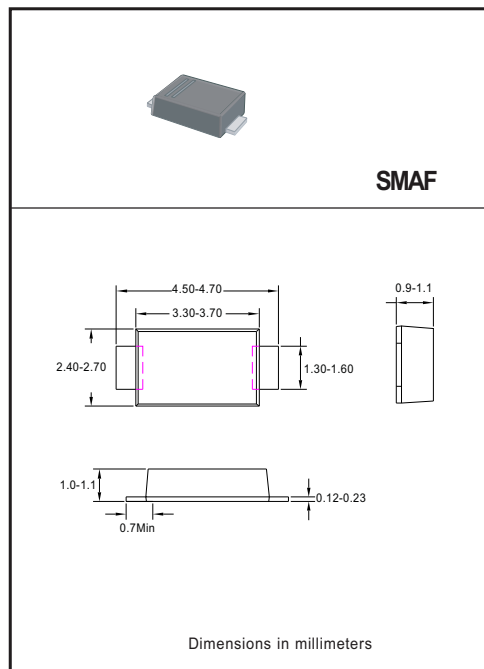

MAXIMUM RATINGS (@ TA=25 °C unless otherwise noted)

RATINGS	SYMBOL	FM2000F	UNITS
Maximum Recurrent Peak Reverse Voltage	V_{RRM}	2000	Volts
Maximum RMS Voltage	V_{RMS}	1400	Volts
Maximum DC Blocking Voltage	V_{DC}	2000	Volts
Maximum Average Forward Rectified Current at Terminals Temperature	I_O	1.0	Amps
Peak Forward Surge Current 8.3 ms single half sine-wave superimposed on rated load (JEDEC method)	I_{FSM}	30	Amps
Current Squared Time	I^2t	3.75	A ² Sec
Typical Thermal Resistance (Note 1)	$R_{\theta JA}$	45	°C/W
Typical Thermal Resistance (Note 1)	$R_{\theta JT}$	10	°C/W
Typical Junction Capacitance (Note 2)	C_J	15	pF
Operating Temperature Range	T_J	-55 to + 175	°C
Storage Temperature Range	T_{STG}	-55 to + 175	°C

ELECTRICAL CHARACTERISTICS (@TA=25 °C unless otherwise noted)

CHARACTERISTICS	SYMBOL	FM2000F	UNITS
Maximum Instantaneous Forward Voltage at 1.0A DC	V_F	1.1	Volts
Maximum Average Reverse Current at Rated DC Blocking Voltage	@ $T_A = 25^\circ\text{C}$	2.0	μA
	@ $T_A = 150^\circ\text{C}$	1.0	mA
Typical Reverse Recovery Time (Note 3)	t_{rr}	2.0	μSec

- NOTES : 1. Thermal Resistance :Mounted on PCB.
2. Measured at 1 MHz and applied reverse voltage of 4.0 volts.
3. Test Conditions: $I_F = 0.5\text{A}$, $I_R = -1.0\text{A}$, $I_{RR} = -0.25\text{A}$.

RATING AND CHARACTERISTICS CURVES (FM2000F)

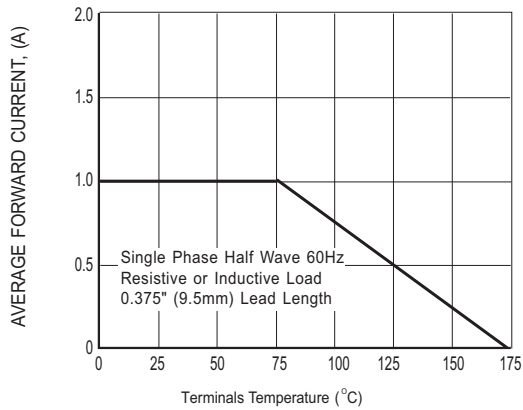

FIG.1 TYPICAL FORWARD CURRENT DERATING CURVE

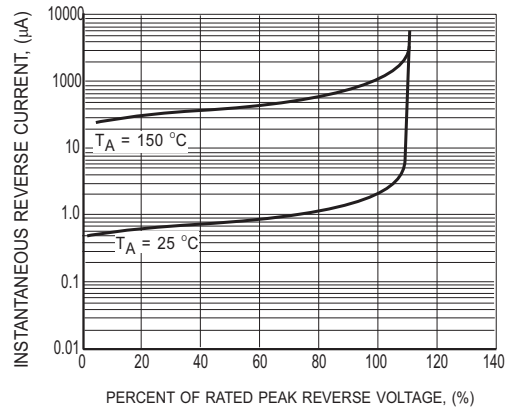

FIG.2 MAXIMUM REVERSE CHARACTERISTICS

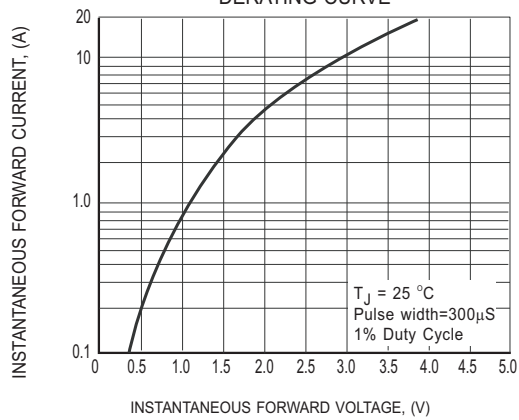

FIG.3 MAXIMUM INSTANTANEOUS FORWARD CHARACTERISTICS

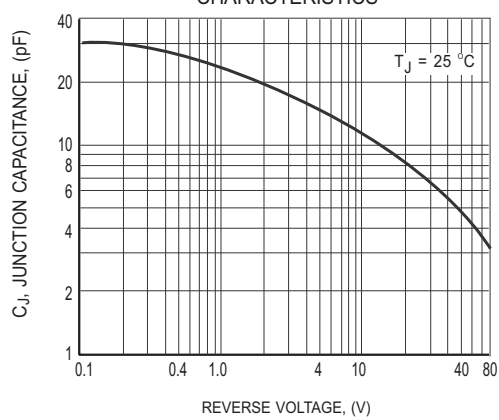

FIG.4 TYPICAL JUNCTION CAPACITANCE

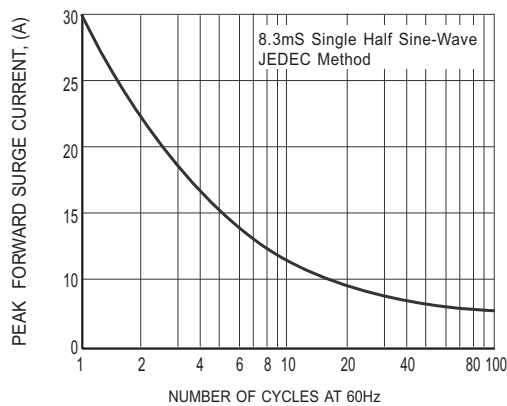
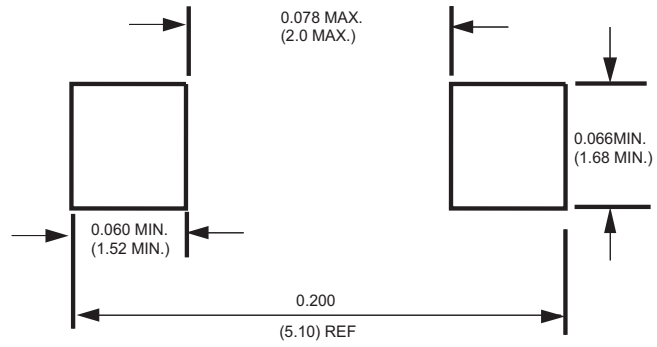

FIG.5 MAXIMUM NON-REPETITIVE FORWARD SURGE CURRENT

Mounting Pad Layout



Dimensions in inches and (millimeters)

Marking Description

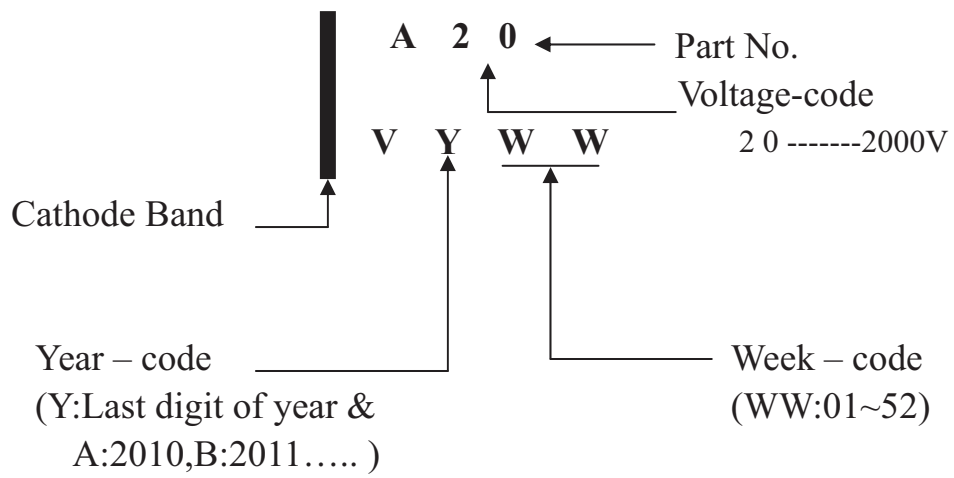

PACKAGING OF DIODE AND BRIDGE RECTIFIERS

REEL PACK

PACKAGE	PACKING CODE	EA PER REEL	EA PER INNER BOX	COMPONENT SPACE (mm)	TAPE SPACE (mm)	REEL DIA (mm)	CARTON SIZE (mm)	EA PER CARTON	GROSS WEIGHT(Kg)
SMAF	-T	3,000	12,000	---	---	178	390*205*310	96,000	---

DISCLAIMER NOTICE

Rectron Inc reserves the right to make changes without notice to any product specification herein, to make corrections, modifications, enhancements or other changes. Rectron Inc or anyone on its behalf assumes no responsibility or liability for any errors or inaccuracies. Data sheet specifications and its information contained are intended to provide a product description only. "Typical" parameters which may be included on RECTRON data sheets and/ or specifications can and do vary in different applications and actual performance may vary over time. Rectron Inc does not assume any liability arising out of the application or use of any product or circuit.

Rectron products are not designed, intended or authorized for use in medical, life-saving implant or other applications intended for life-sustaining or other related applications where a failure or malfunction of component or circuitry may directly or indirectly cause injury or threaten a life without expressed written approval of Rectron Inc. Customers using or selling Rectron components for use in such applications do so at their own risk and shall agree to fully indemnify Rectron Inc and its subsidiaries harmless against all claims, damages and expenditures.