

RATING AND CHARACTERISTICS CURVES (FR201W THRU FR207W)

FIG.1 TYPICAL FORWARD CURRENT DERATING CURVE

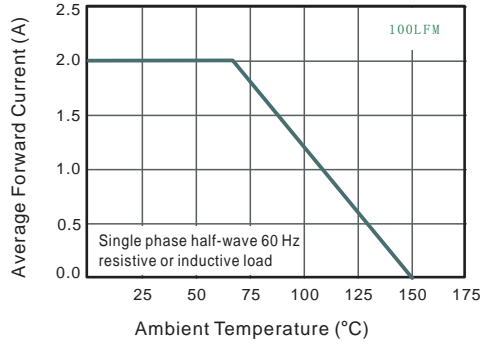

FIG.2 MAXIMUM REVERSE CHARACTERISTICS

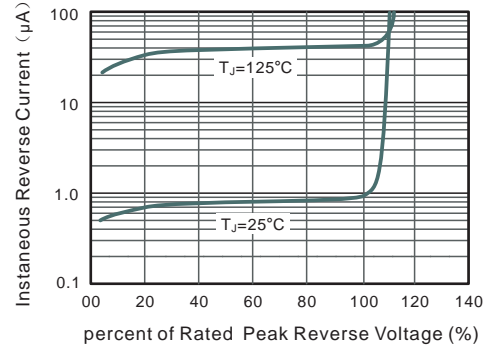

FIG.3 MAXIMUM INSTANTANEOUS FORWARD CHARACTERISTICS

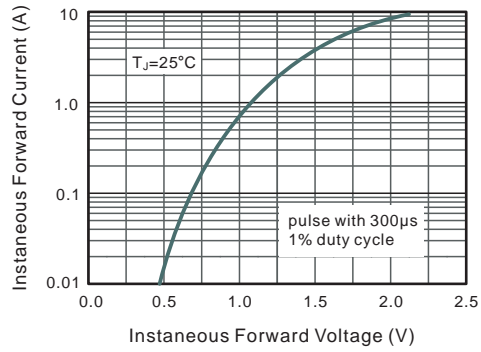

FIG.4 TYPICAL DIODE CAPACITANCE

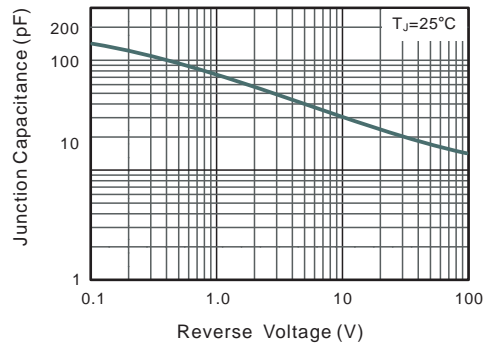
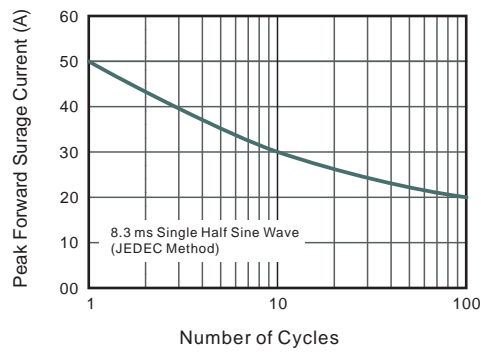

FIG.5 MAXIMUM NON-REPETITIVE FORWARD SURGE CURRENT



PACKAGE OUTLINE

Plastic surface mounted package; 2 leads

SOD123F(L)

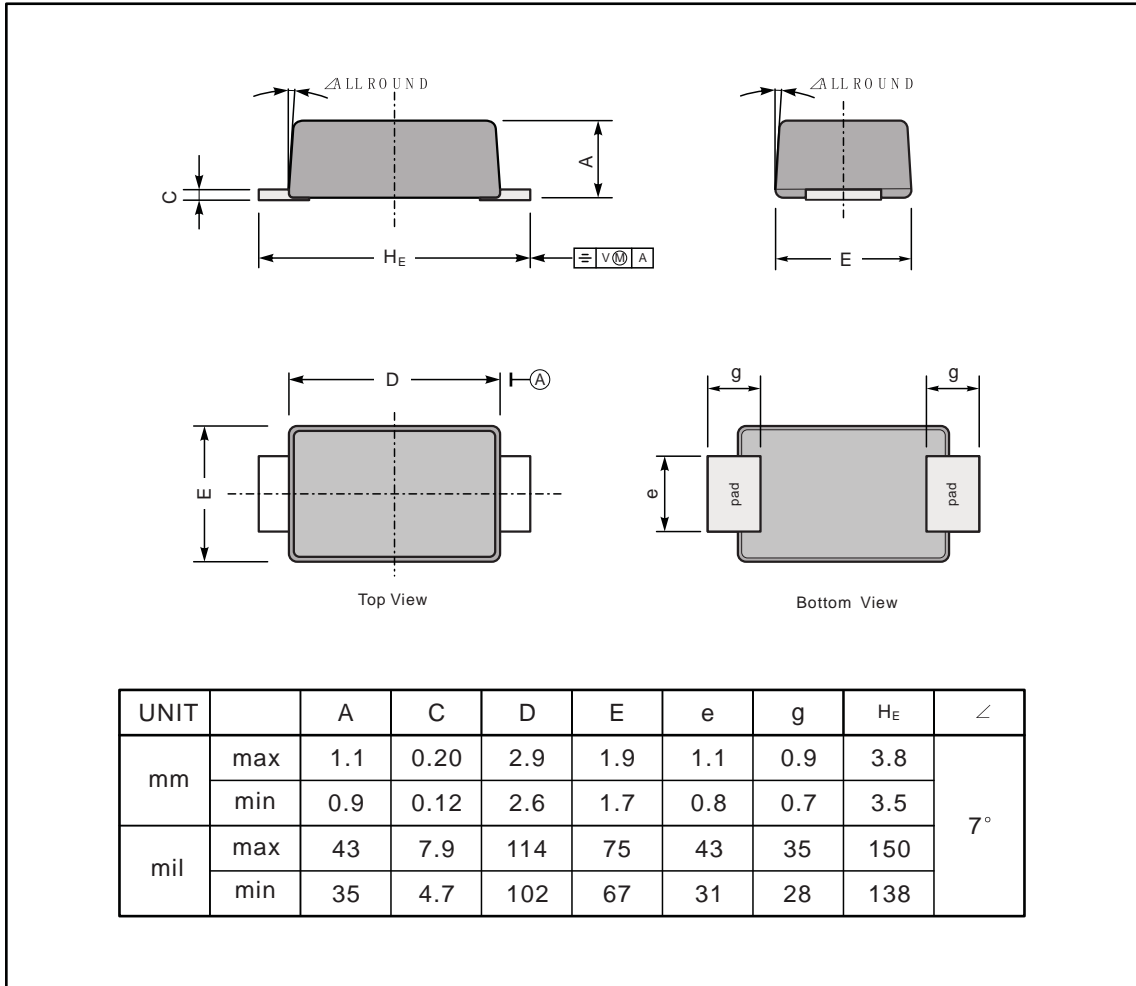

The recommended mounting pad size

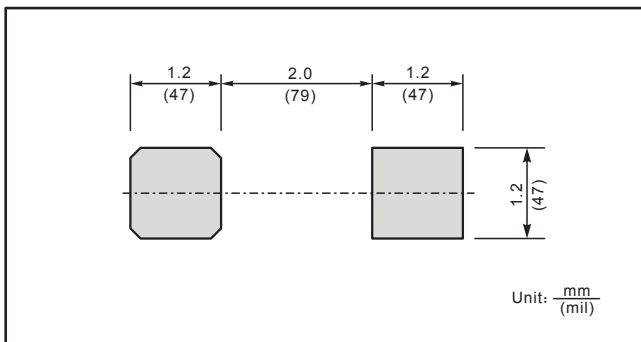

Marking

Type number	Marking code
FR201W	2F1
FR202W	2F2
FR203W	2F3
FR204W	2F4
FR205W	2F5
FR206W	2F6
FR207W	2F7

PACKAGING OF DIODE AND BRIDGE RECTIFIERS

5((/ 3\$&.

3\$&.\$*(3\$&.,1 &2'(5((/	*(\$ 3(5 ,11(5 %2;	(\$ 3(5 63\$&(PP	&20321(17 7\$3(6\$& PP	5((/ ', PP	\$&\$5721 6, PP	≠\$ 3(5 &\$572	*5266 :(, *+7 .J
62') /	:							

DISCLAIMER NOTICE

Rectron Inc reserves the right to make changes without notice to any product specification herein, to make corrections, modifications, enhancements or other changes. Rectron Inc or anyone on its behalf assumes no responsibility or liability for any errors or inaccuracies. Data sheet specifications and its information contained are intended to provide a product description only. "Typical" parameters which may be included on RECTRON data sheets and/ or specifications can and do vary in different applications and actual performance may vary over time. Rectron Inc does not assume any liability arising out of the application or use of any product or circuit.

Rectron products are not designed, intended or authorized for use in medical, life-saving implant or other applications intended for life-sustaining or other related applications where a failure or malfunction of component or circuitry may directly or indirectly cause injury or threaten a life without expressed written approval of Rectron Inc. Customers using or selling Rectron components for use in such applications do so at their own risk and shall agree to fully indemnify Rectron Inc and its subsidiaries harmless against all claims, damages and expenditures.