

HIGH EFFICIENCY RECTIFIER
VOLTAGE 1200 Volts CURRENT 10 Ampere

FEATURES

- * Low power loss,high efficiency
- * Low leakage
- * Low forward voltage drop
- * High current capability
- * High speed switching
- * High reliability
- * High current surge

MECHANICAL DATA

- * Epoxy: Device has UL flammability classification 94V-O
- * Case: ITO-220A Molded plastic
- * Lead: MIL-STD-202E method 208C guaranteed
- * Mounting position: Any

MAXIMUM RATINGS AND ELECTRICAL CHARACTERISTICS

Ratings at 25 °C ambient temperature unless otherwise specified.
Single phase, half wave, 60 Hz, resistive or inductive load.
For capacitive load, derate current by 20%.



ITO-220A

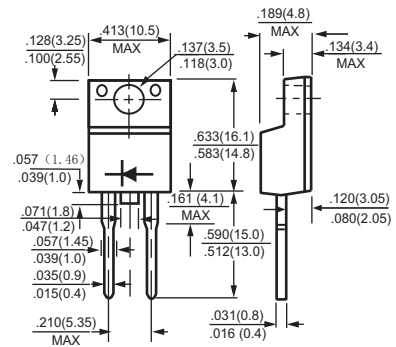

Dimensions in inches and (millimeters)

MAXIMUM RATINGS (@ TA=25 °C unless otherwise noted)

RATINGS	SYMBOL	IHER1012	UNITS
Maximum Recurrent Peak Reverse Voltage	V_{RRM}	1200	Volts
Maximum RMS Voltage	V_{RMS}	840	Volts
Maximum DC Blocking Voltage	V_{DC}	1200	Volts
Maximum Average Forward Rectified Current at $T_C = 100^\circ C$	I_o	10	Amps
Peak Forward Surge Current 8.3 ms single half sine-wave superimposed on rated load (JEDEC method)	I_{FSM}	150	Amps
Current Squared Time	I^2t	93.38	A^2/Sec
Typical Thermal Resistance (Note 1)	$R_{\theta JA}$	5	$^\circ C/W$
Operating Temperature Range	T_J	-55 to + 150	$^\circ C$
Storage Temperature Range	T_{STG}	-55 to + 150	$^\circ C$

ELECTRICAL CHARACTERISTICS (@TA=25 °C unless otherwise noted)

CHARACTERISTICS	SYMBOL	IHER1012	UNITS
Maximum Instantaneous Forward Voltage at 10A DC	V_F	3.5	Volts
Maximum Average Reverse Current at Rated DC Blocking Voltage	@ $T_A = 25^\circ C$	10	μA
	@ $T_A = 125^\circ C$	500	
Maximum Reverse Recovery Time (Note 2)	t_{rr}	75	nSec

- NOTES : 1. Thermal Resistance : At 9.5mm lead length,PCB mounted.
2. Test Conditions: $I_F = 0.5A$, $I_R = -1.0A$, $I_{RR} = -0.25A$.
3. " ROHS compliant"

RATING AND CHARACTERISTICS CURVES (IHER1012)

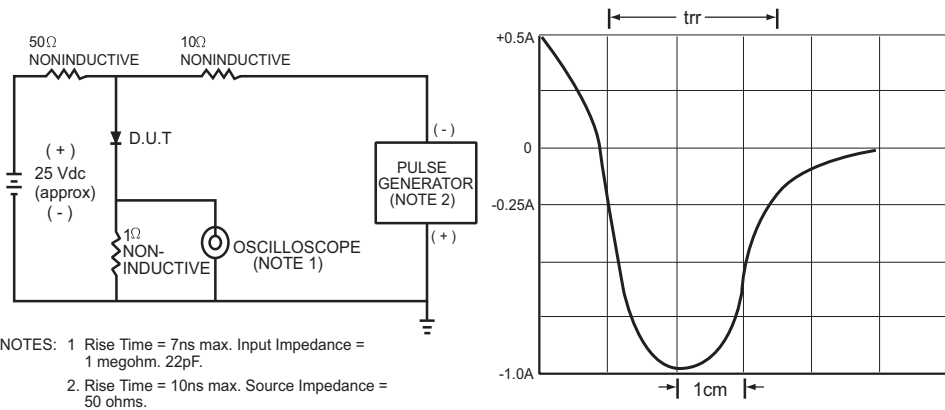

FIG.1 TEST CIRCUIT DIAGRAM AND REVERSE RECOVERY TIME CHARACTERISTIC

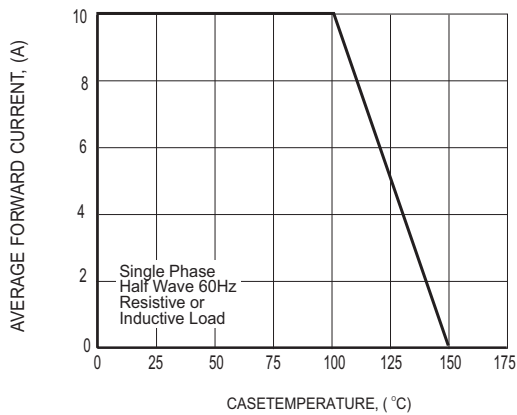

FIG.2 TYPICAL FORWARD CURRENT DERATING CURVE

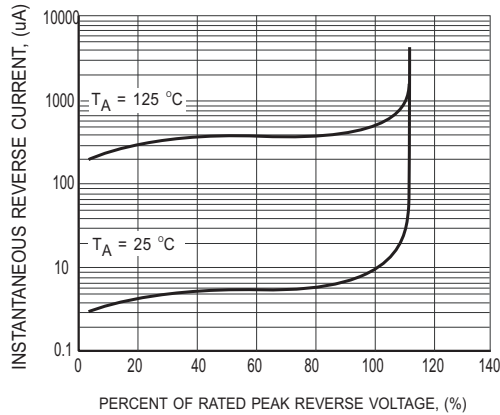

FIG.3 MAXIMUM REVERSE CHARACTERISTICS

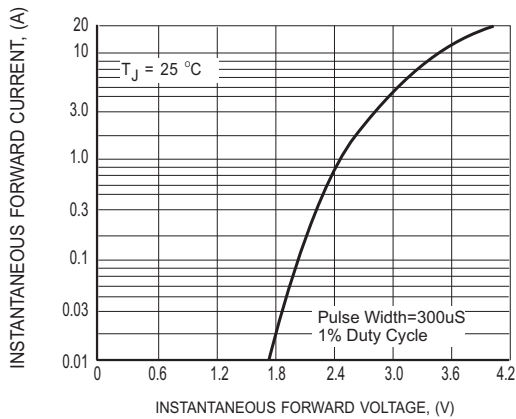

FIG.4 MAXIMUM INSTANTANEOUS FORWARD CHARACTERISTICS

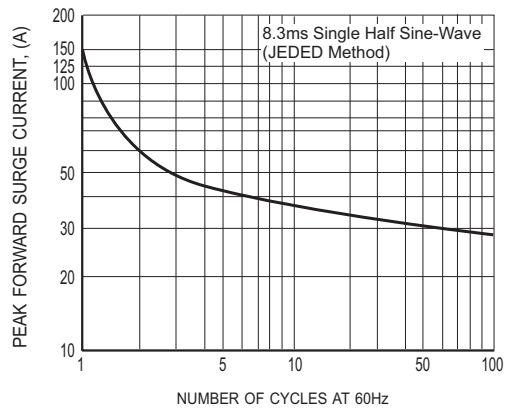
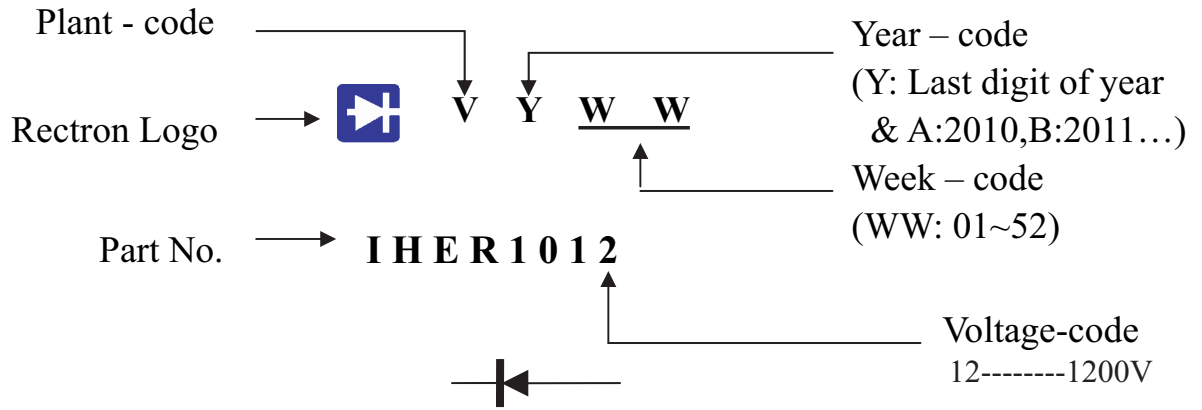

FIG.5 MAXIMUM NON-REPETITIVE FORWARD SURGE CURRENT

Marking Description



PACKAGING OF DIODE AND BRIDGE RECTIFIERS

TUBE PACK

PACKAGE	PACKING CODE	EA PER BOX	INNER BOX SIZE (mm)	CARTON SIZE (mm)	EA PER CARTON	WEIGHT(Kg)
(I)TO-220/TO-220(A)	-C	2,000	550*140*92	572*308*120	4,000	11.80

DISCLAIMER NOTICE

Rectron Inc reserves the right to make changes without notice to any product specification herein, to make corrections, modifications, enhancements or other changes. Rectron Inc or anyone on its behalf assumes no responsibility or liability for any errors or inaccuracies. Data sheet specifications and its information contained are intended to provide a product description only. "Typical" parameters which may be included on RECTRON data sheets and/ or specifications can and do vary in different applications and actual performance may vary over time. Rectron Inc does not assume any liability arising out of the application or use of any product or circuit.

Rectron products are not designed, intended or authorized for use in medical, life-saving implant or other applications intended for life-sustaining or other related applications where a failure or malfunction of component or circuitry may directly or indirectly cause injury or threaten a life without expressed written approval of Rectron Inc. Customers using or selling Rectron components for use in such applications do so at their own risk and shall agree to fully indemnify Rectron Inc and its subsidiaries harmless against all claims, damages and expenditures.