

**GLASS PASSIVATED SILICON RECTIFIER**

**VOLTAGE RANGE 600 Volts CURRENT 15.0 Amperes**

**FEATURES**

- \* Low leakage
- \* Low forward voltage drop
- \* High current capability
- \* High surge capability
- \* High reliability

**MECHANICAL DATA**

- \* Case: ITO-220A molded plastic
- \* Epoxy: Device has UL flammability classification 94V-0
- \* Mounting position: Any

**MAXIMUM RATINGS AND ELECTRICAL CHARACTERISTICS**

Ratings at 25 °C ambient temperature unless otherwise specified.  
Single phase, half wave, 60 Hz, resistive or inductive load.  
For capacitive load, derate current by 20%.

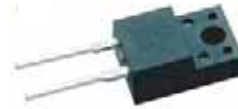

**ITO-220A**

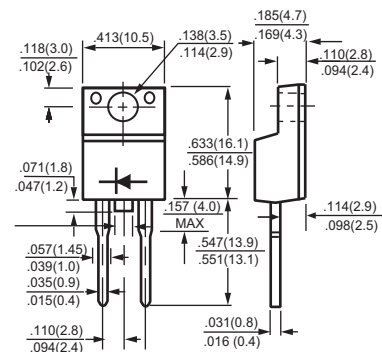

**MAXIMUM RATINGS (@ TA=25 °C unless otherwise noted)**

RATINGS	SYMBOL	MUR1560	UNITS
Maximum Recurrent Peak Reverse Voltage	V <sub>RRM</sub>	600	Volts
Maximum RMS Voltage	V <sub>RMS</sub>	420	Volts
Maximum DC Blocking Voltage	V <sub>DC</sub>	600	Volts
Maximum Average Forward Rectified Current at T <sub>C</sub> = 100 °C	I <sub>O</sub>	15.0	Amps
Peak Forward Surge Current 8.3 ms single half sine-wave superimposed on rated load (JEDEC method)	I <sub>FSM</sub>	250	Amps
Typical Current Squared Time	I <sup>2</sup> <sub>t</sub>	260	A <sup>2</sup> S
Typical Thermal Resistance (Note 1)	R <sub>θJC</sub>	6.6	°C/W
	R <sub>θJA</sub>	8.3	
Total Junction Capacitance (Note 2)	C <sub>t</sub>	265	pF
Operating and Storage Temperature Range	T <sub>J</sub> , T <sub>STG</sub>	-55 to + 150	°C

**ELECTRICAL CHARACTERISTICS (@TA=25 °C unless otherwise noted)**

CHARACTERISTICS	SYMBOL	MUR1560	UNITS
Maximum Instantaneous Forward Voltage at 15.0A DC	V <sub>F</sub>	1.6	Volts
Maximum DC Reverse Current at Rated DC Blocking Voltage	@T <sub>A</sub> = 25°C	1.0	uAmps
	@T <sub>A</sub> = 125°C	500	
Maximum Reverse recovery time(Note 5)	T <sub>rr</sub>	35	nS

- NOTES : 1. Thermal Resistance : Heat-sink case mounted or if PCB mounted.  
2. Measured at 1 MHz and applied reverse voltage of 4.0 volts.  
3. "Fully ROHS compliant", "100% Sn plating (Pb-free)".  
4. Available in Halogen-free epoxy by adding suffix -HF after the part nbr.  
5. IF= 0.5A,Irr= 0.25A,IR =1.0A.

## RATING AND CHARACTERISTICS CURVES ( MUR1560 )

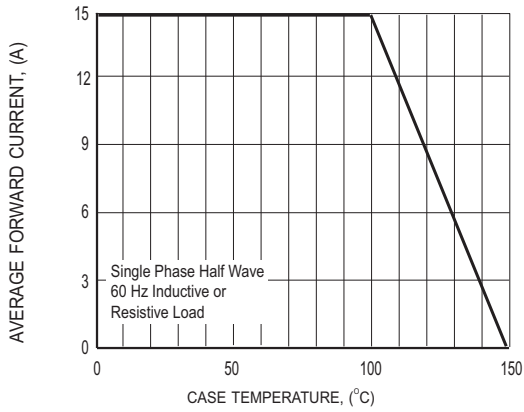

FIG.1 TYPICAL FORWARD CURRENT DERATING CURVE

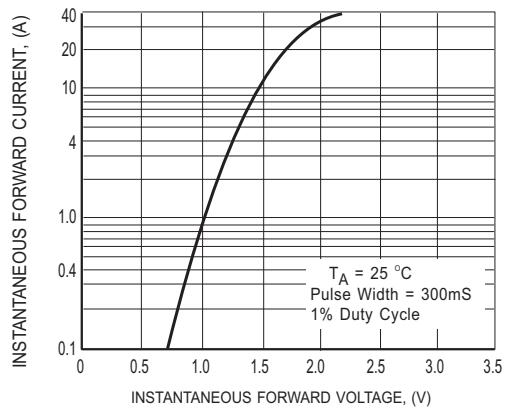

FIG.2 MAXIMUM INSTANTANEOUS FORWARD CHARACTERISTICS

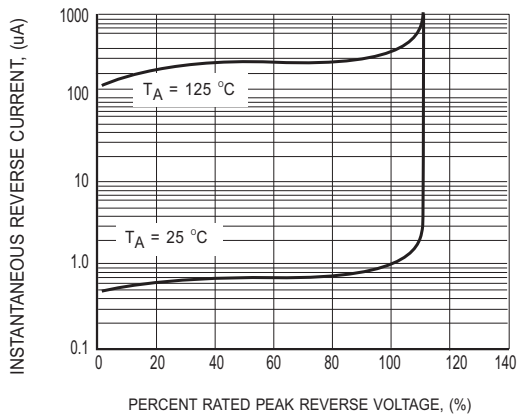

FIG.3 MAXIMUM REVERSE CHARACTERISTICS

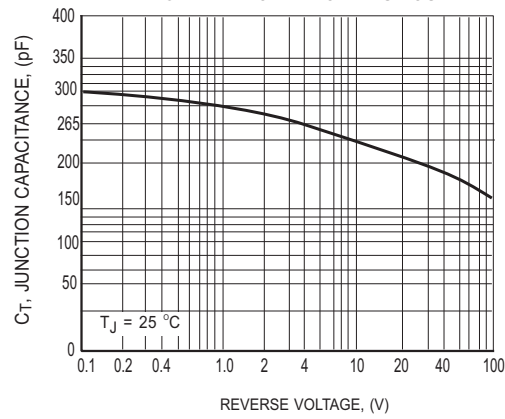

FIG.4 TOTAL JUNCTION CAPACITANCE

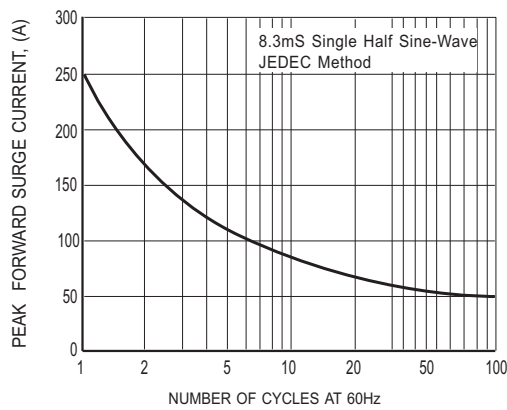

FIG.5 MAXIMUM NON-REPETITIVE FORWARD SURGE CURRENT



## Attachment information about MUR1560

### 1. Internal Circuit



### 2. Marking on the body

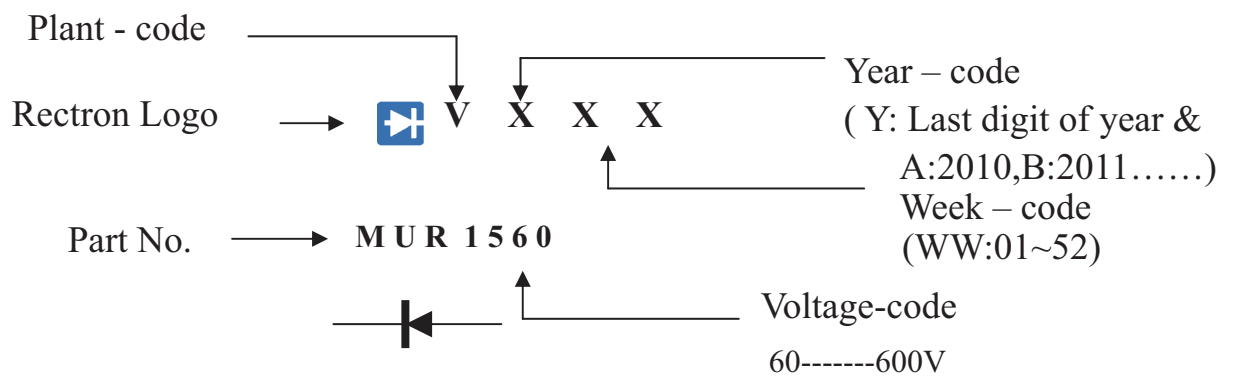

# PACKAGING OF DIODE AND BRIDGE RECTIFIERS

## TUBE PACK

PACKAGE	PACKING CODE	EA PER BOX	INNER BOX SIZE (mm)	CARTON SIZE (mm)	EA PER CARTON	WEIGHT(Kg)
(I)TO-220/TO-220(A)	-C	2,000	550*140*92	572*308*120	4,000	11.80

## DISCLAIMER NOTICE

Rectron Inc reserves the right to make changes without notice to any product specification herein, to make corrections, modifications, enhancements or other changes. Rectron Inc or anyone on its behalf assumes no responsibility or liability for any errors or inaccuracies. Data sheet specifications and its information contained are intended to provide a product description only. "Typical" parameters which may be included on RECTRON data sheets and/ or specifications can and do vary in different applications and actual performance may vary over time. Rectron Inc does not assume any liability arising out of the application or use of any product or circuit.

Rectron products are not designed, intended or authorized for use in medical, life-saving implant or other applications intended for life-sustaining or other related applications where a failure or malfunction of component or circuitry may directly or indirectly cause injury or threaten a life without expressed written approval of Rectron Inc. Customers using or selling Rectron components for use in such applications do so at their own risk and shall agree to fully indemnify Rectron Inc and its subsidiaries harmless against all claims, damages and expenditures.