

ULTRAFAST RECOVERY RECTIFIERS

FEATURES

- High speed switching capability
- High current capability
- High forward surge capability
- Low power losses, High efficiency
- High reliability
- For use in low voltage, high frequency inverters
- P/N suffix V means AEC-Q101 qualified, e.g MUR3060CV
- P/N suffix V means Halogen-free

APPLICATIONS

Fast recovery diode, mainly used for rectification, used in high-power equipment, The express and ultrafast recovery diodes are suitable for high frequency and ultra high frequency circuits, respectively

MECHANICAL DATA

- **Case:** Molded plastic
- **Polarity:** As marked
- **Mounting Position:** Any
- **Molded Plastic:** UL Flammability Classification Rating 94V-0
- Lead free in compliance with EU RoHS 2011/65/EU directive
- Solder bath temperature 275°C maximum, 10s per JESD 22-B106

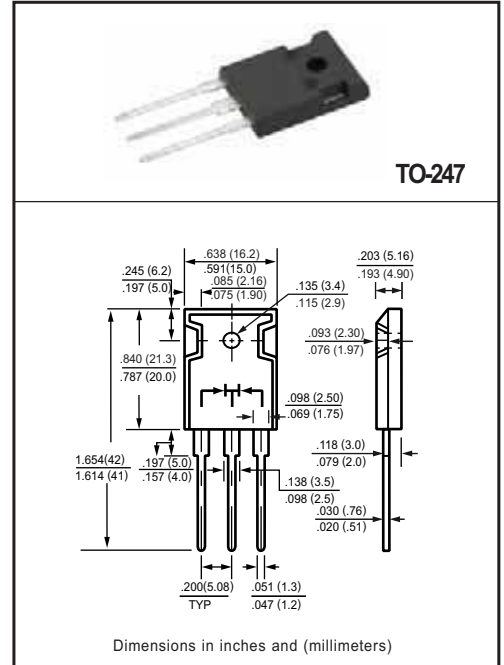

Maximum Ratings (Per Leg) at Ta=25°C unless otherwise specified

Characteristics	Symbol	Value	Unit
Maximum Repetitive Peak Reverse Voltage	V_{RRM}	600	V
Working Peak Reverse Voltage	V_{RWM}	600	V
Maximum DC Blocking Voltage	V_{DC}	600	V
Maximum Average Forward Rectified Current	Per Leg	15	A
	Total	30	
Peak Forward Surge Current, 8.3 ms Single Half Sine-wave	I_{FSM}	250	A
Typical Current Square Time	$I^2 T$	260	A ² S
Operating Temperature Range	T_J	-40 to +150	°C
Storage Temperature Range	T_{STG}	-40 to +150	°C
Typical Thermal Resistance (Note1)	$R_{\theta JC}$	2	°C/W

Note1: Thermal resistance from Junction to case per leg mounted on heatsink.

Electrical Characteristics (Per Leg) unless otherwise specified

Characteristics	Symbol	Value		Unit	
		Typ.	Max.		
Forward Voltage Drop(Note2)	V_F	Typ.	Max.	V	
at $I_F=3A$		TA=25°C	0.92		-
		TA=125°C	0.73		-
at $I_F=5A$		TA=25°C	0.99		-
		TA=125°C	0.80		-
at $I_F=15A$		TA=25°C	1.20		1.59
	TA=125°C	1.00	-		
Maximum Reverse Current at $V_R=600V$	I_R	TA=25°C	0.03	1	
		TA=125°C	11	-	
Maximum Reverse Recovery Time at $I_F=0.5A, I_R=1A, I_{RR}=0.25A$	T_{rr}	-	50	ns	

Note2: Pulse test: 300 μs pulse width, 1 % duty cycle

RATING AND CHARACTERISTICS CURVES (MUR3060C)

FIG. 1 MAXIMUM FORWARD CURRENT DERATING CURVE

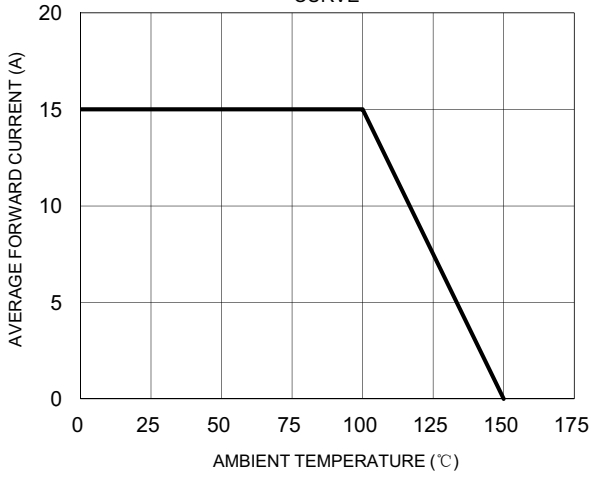

FIG. 2 MAXIMUM NON-REPETITIVE FORWARD SURGE CURRENT PER LEG

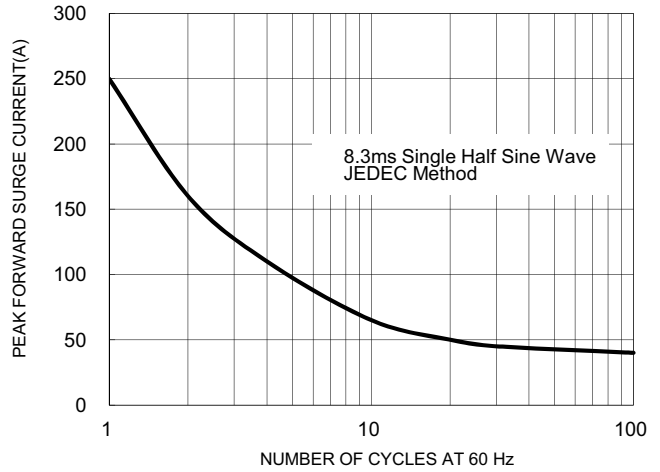

FIG. 3 TYPICAL FORWARD CHARACTERISTICS PER LEG

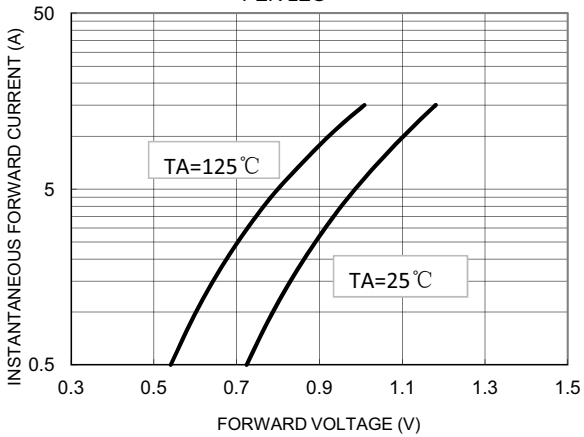
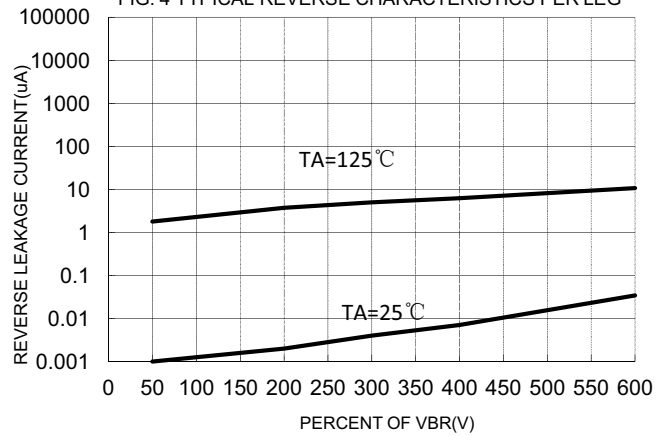
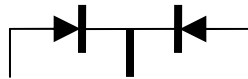
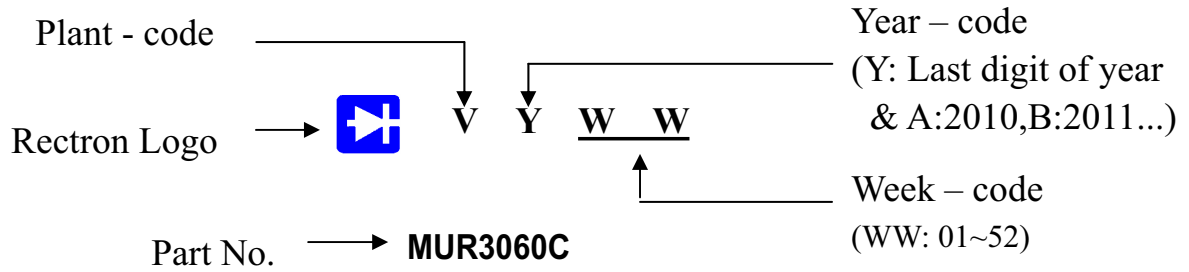

FIG. 4 TYPICAL REVERSE CHARACTERISTICS PER LEG



Marking Description



Ordering information

Code	Package	Unit Weight	Base Quantity	Delivery mode
-C	TO-247	0.209oz(5.93g)	30 pcs / tube	600pcs/box 2400pcs/carton

DISCLAIMER NOTICE

Rectron Inc reserves the right to make changes without notice to any product specification herein, to make corrections, modifications, enhancements or other changes. Rectron Inc or anyone on its behalf assumes no responsibility or liability for any errors or inaccuracies. Data sheet specifications and its information contained are intended to provide a product description only. "Typical" parameters which may be included on RECTRON data sheets and/ or specifications can and do vary in different applications and actual performance may vary over time. Rectron Inc does not assume any liability arising out of the application or use of any product or circuit.

Rectron products are not designed, intended or authorized for use in medical, life-saving implant or other applications intended for life-sustaining or other related applications where a failure or malfunction of component or circuitry may directly or indirectly cause injury or threaten a life without expressed written approval of Rectron Inc. Customers using or selling Rectron components for use in such applications do so at their own risk and shall agree to fully indemnify Rectron Inc and its subsidiaries harmless against all claims, damages and expenditures.