

**ULTRAFAST RECTIFIER**

**VOLTAGE RANGE 200 to 600 Volts CURRENT 2.0 Amperes**

**FEATURES**

- \* High reliability
- \* Low leakage
- \* Low forward voltage
- \* High current capability
- \* Ultrafast switching speed
- \* High surge capability
- \* Good for switching mode circuit

**MECHANICAL DATA**

- \* Case: Molded plastic
- \* Epoxy: Device has UL flammability classification 94V-0
- \* Lead: MIL-STD-202E method 208C guaranteed
- \* Mounting position: Any
- \* P/N suffix V means AEC-Q101 qualified, e.g:MURS220AV
- \* P/N suffix V means Halogen-free

**MAXIMUM RATINGS AND ELECTRICAL CHARACTERISTICS**

Ratings at 25 °C ambient temperature unless otherwise specified.  
Single phase, half wave, 60 Hz, resistive or inductive load.  
For capacitive load, derate current by 20%.

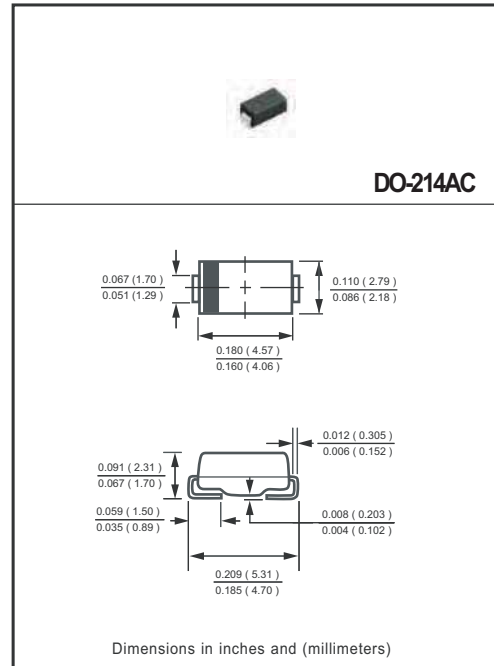

**MAXIMUM RATINGS (@ TA=25 °C unless otherwise noted)**

RATINGS	SYMBOL	MURS220A	MURS240A	MURS260A	UNITS
Maximum Recurrent Peak Reverse Voltage	V <sub>RRM</sub>	200	400	600	Volts
Maximum RMS Voltage	V <sub>RMS</sub>	140	280	420	Volts
Maximum DC Blocking Voltage	V <sub>DC</sub>	200	400	600	Volts
Maximum Average Forward Rectified Current at T <sub>A</sub> =55°C	I <sub>O</sub>	2.0			Amps
Peak Forward Surge Current 8.3 ms single half sine-wave superimposed on rated load (JEDEC method)	I <sub>FSM</sub>	40	35		Amps
Current Square me	I <sup>2</sup> t	6.6	5.08		A <sup>2</sup> S
Operating and Storage Temperature Range	T <sub>J</sub> , T <sub>STG</sub>	-55 to + 150			°C

**ELECTRICAL CHARACTERISTICS (@T<sub>A</sub>=25 °C unless otherwise noted)**

CHARACTERISTICS	SYMBOL	MURS220A	MURS240A	MURS260A	UNITS
Maximum Instantaneous Forward Voltage at 2.0A DC	V <sub>F</sub>	0.95	1.30	1.45	Volts
Maximum DC Reverse Current at Rated DC Blocking Voltage	I <sub>R</sub>	@T <sub>A</sub> = 25°C	5		uAmps
		@T <sub>A</sub> = 150°C	800		
Maximum Reverse Recovery Time (Note 1)	t <sub>rr</sub>	25	50		nSec

NOTES : 1. Test Conditions: I<sub>F</sub> = 0.5A, I<sub>R</sub> = -1.0A, I<sub>RR</sub> = -0.25A  
2. \* ROHS compliant\*  
3. Available in Halogen-free epoxy by adding suffix -HF after the part nbr.

# RATING AND CHARACTERISTICS CURVES ( MURS220A THRU MURS260A )

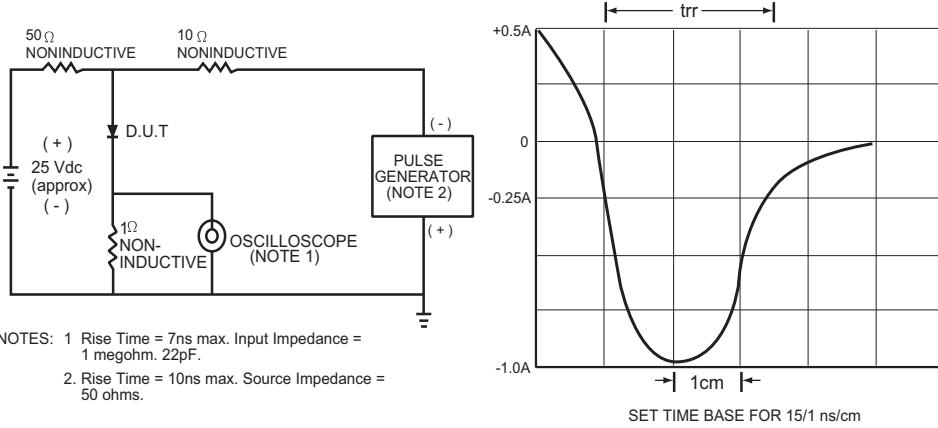

FIG.1 TEST CIRCUIT DIAGRAM AND REVERSE RECOVERY TIME CHARACTERISTIC

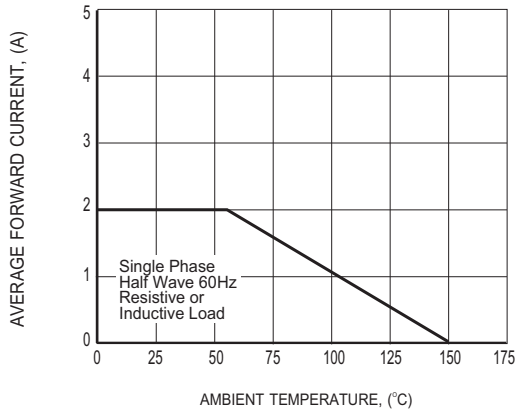

FIG.2 TYPICAL FORWARD CURRENT DERATING CURVE

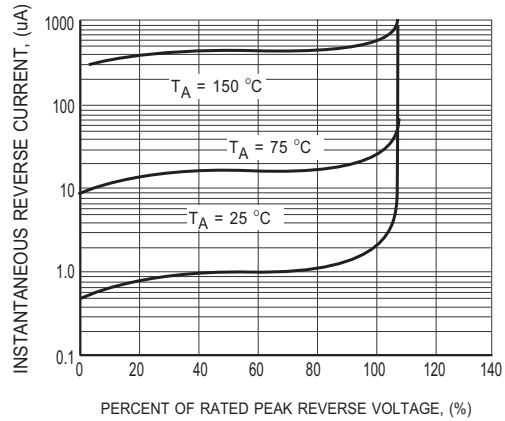

FIG.3 MAXIMUM REVERSE CHARACTERISTICS

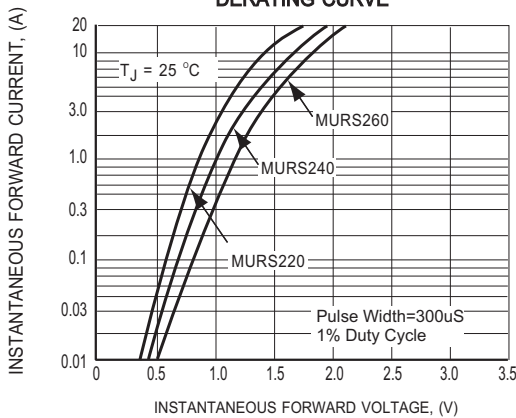

FIG.4 MAXIMUM INSTANTANEOUS FORWARD CHARACTERISTICS

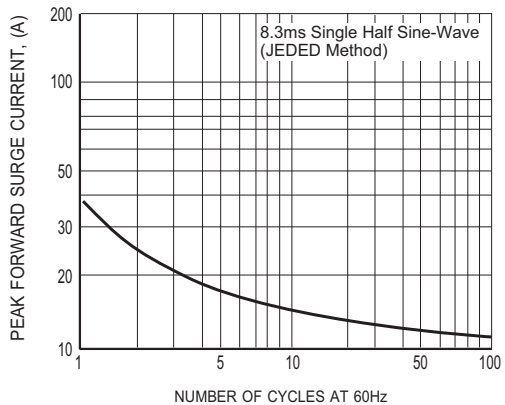
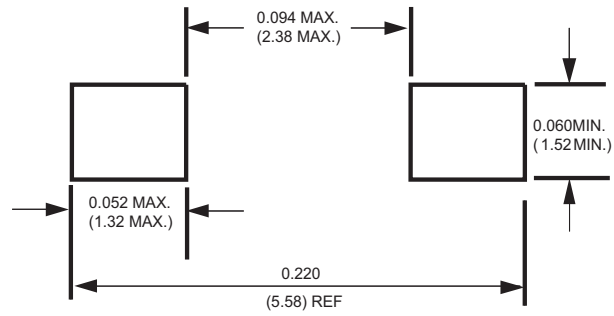

FIG.5 MAXIMUM NON-REPETITIVE FORWARD SURGE CURRENT

## Mounting Pad Layout



Dimensions in inches and (millimeters)

## Marking Description

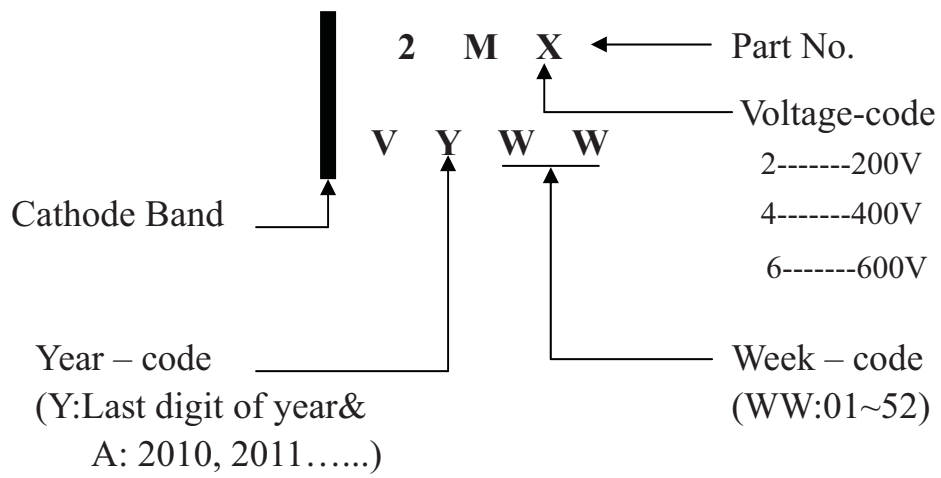

## PACKAGING OF DIODE AND BRIDGE RECTIFIERS

### REEL PACK

PACKAGE	PACKING CODE	EA PER REEL	EA PER INNER BOX	COMPONENT SPACE (mm)	TAPE SPACE (mm)	REEL DIA (mm)	CARTON SIZE (mm)	EA PER CARTON	GROSS WEIGHT(Kg)
SMA	-W	7,500	15,000	---	---	330	360*355*360	120,000	15.2

PACKAGE	PACKING CODE	EA PER REEL	EA PER INNER BOX	COMPONENT SPACE (mm)	TAPE SPACE (mm)	REEL DIA (mm)	CARTON SIZE (mm)	EA PER CARTON	GROSS WEIGHT(Kg)
SMA	-T	2,000	8,000	---	---	178	390*205*310	64,000	7.8

## DISCLAIMER NOTICE

Rectron Inc reserves the right to make changes without notice to any product specification herein, to make corrections, modifications, enhancements or other changes. Rectron Inc or anyone on its behalf assumes no responsibility or liability for any errors or inaccuracies. Data sheet specifications and its information contained are intended to provide a product description only. "Typical" parameters which may be included on RECTRON data sheets and/ or specifications can and do vary in different applications and actual performance may vary over time. Rectron Inc does not assume any liability arising out of the application or use of any product or circuit.

Rectron products are not designed, intended or authorized for use in medical, life-saving implant or other applications intended for life-sustaining or other related applications where a failure or malfunction of component or circuitry may directly or indirectly cause injury or threaten a life without expressed written approval of Rectron Inc. Customers using or selling Rectron components for use in such applications do so at their own risk and shall agree to fully indemnify Rectron Inc and its subsidiaries harmless against all claims, damages and expenditures.