

GLASS PASSIVATED SILICON RECTIFIER
VOLTAGE RANGE 50 to 1000 Volts CURRENT 16 Amperes

FEATURES

- * Low power loss, high efficiency
- * Low forward voltage drop
- * Low thermal resistance
- * High current capability
- * High surge capability
- * High reliability

MECHANICAL DATA

- * Case: TO-220 molded plastic
- * Epoxy: Device has UL flammability classification 94V-0
- * Lead: MIL-STD-202E method 208C guaranteed
- * Mounting position: Any
- * Polarity: As marked

MAXIMUM RATINGS AND ELECTRICAL CHARACTERISTICS

Ratings at 25 °C ambient temperature unless otherwise specified.
Single phase, half wave, 60 Hz, resistive or inductive load.
For capacitive load, derate current by 20%.



TO-220

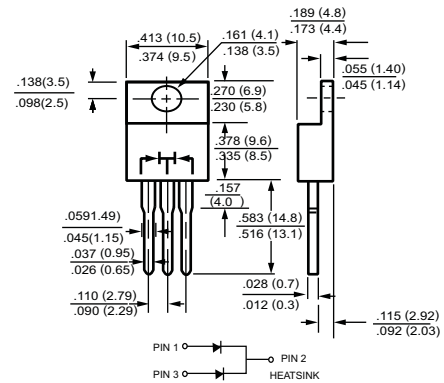

Dimensions in inches and (millimeters)

MAXIMUM RATINGS (At TA = 25°C unless otherwise noted)

RATINGS	SYMBOL	RL16 01C	RL16 02C	RL16 03C	RL16 04C	RL16 05C	RL16 06C	RL16 07C	UNITS
Maximum Recurrent Peak Reverse Voltage	VRRM	50	100	200	400	600	800	1000	Volts
Maximum RMS Voltage	VRMS	35	70	140	280	420	560	700	Volts
Maximum DC Blocking Voltage	VDC	50	100	200	400	600	800	1000	Volts
Maximum Average Forward Rectified Current Tc 100°C (Note 1)	Io	16.0							Amps
Peak Forward Surge Current, 8.3 ms single half sine-wave superimposed on rated load (JEDEC method)	IFSM	200							Amps
Typical Current Squared Time	i ² t	166							A ² S
Typical Thermal Resistance	RθJC	3.0							°C/W
Typical Junction Capacitance (Note 2)	Cj	40							pF
Operating and Storage Temperature Range	TJ, TSTG	-65 to + 150							°C

ELECTRICAL CHARACTERISTICS (At TA = 25°C unless otherwise noted)

CHARACTERISTICS	SYMBOL	RL16 01C	RL16 02C	RL16 03C	RL16 04C	RL16 05C	RL16 06C	RL16 07C	UNITS
Maximum Instantaneous Forward Voltage at 8.0A DC	VF	1.1							Volts
Maximum DC Reverse Current at Rated DC Blocking Voltage	@Tc = 25°C	10							uAmps
	@Tc = 100°C	100							

NOTES : 1. Case Temperature Measured at Metal Tab.
2. Measured at 1 MHz and applied reverse voltage of 4.0 volts.
3. Suffix " A " = Common Anode.

RATING AND CHARACTERISTIC CURVES (RL1601C THRU RL1607C)

FIG. 1 - TYPICAL FORWARD CURRENT DERATING CURVE

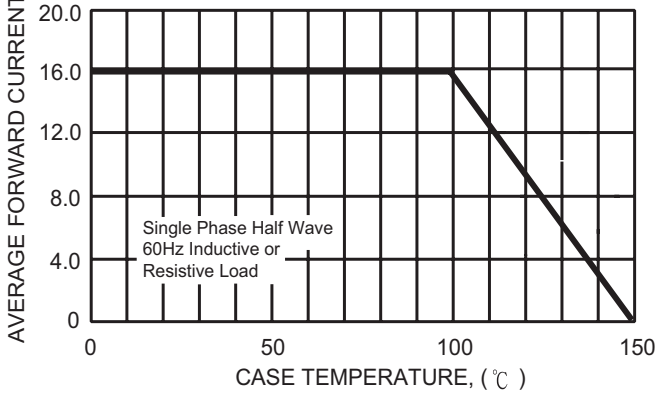

FIG. 2 - TYPICAL REVERSE CHARACTERISTICS

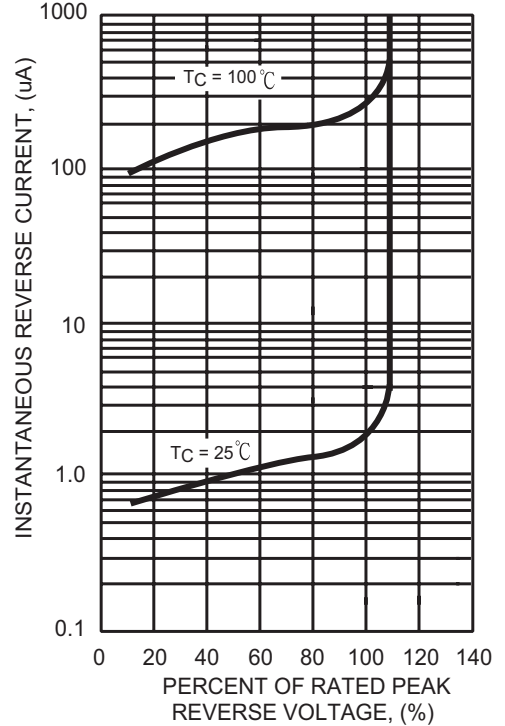

FIG. 3 - MAXIMUM NON-REPETITIVE FORWARD SURGE CURRENT

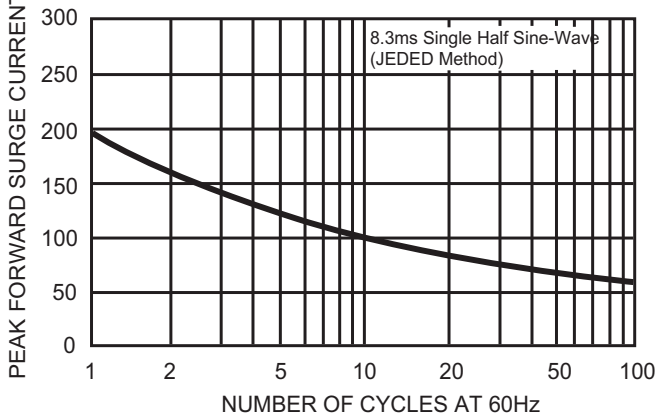

FIG. 4 - TYPICAL JUNCTION CAPACITANCE

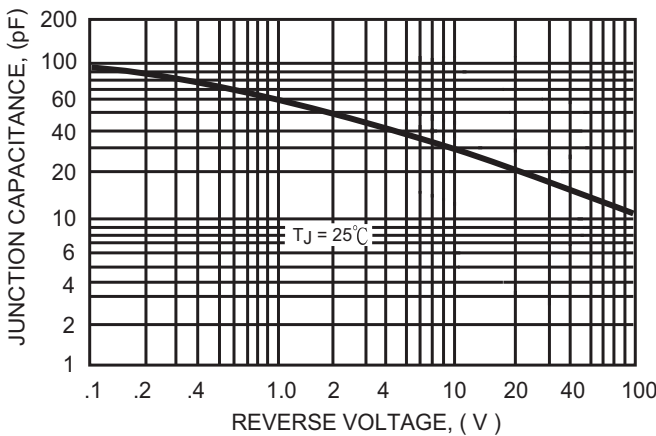
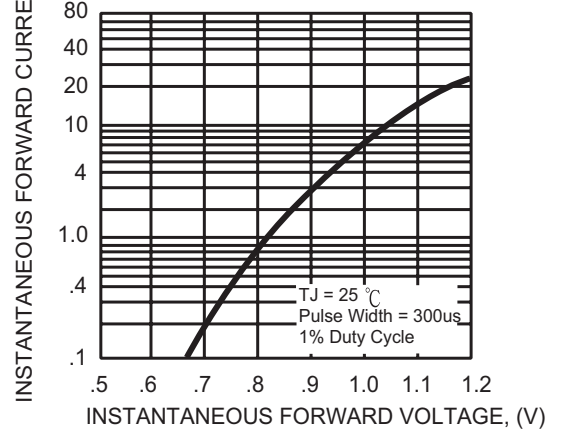

FIG. 5 - TYPICAL INSTANTANEOUS FORWARD CHARACTERISTICS





Attachment information about RL160XC

1. Internal Circuit



2. Marking on the body

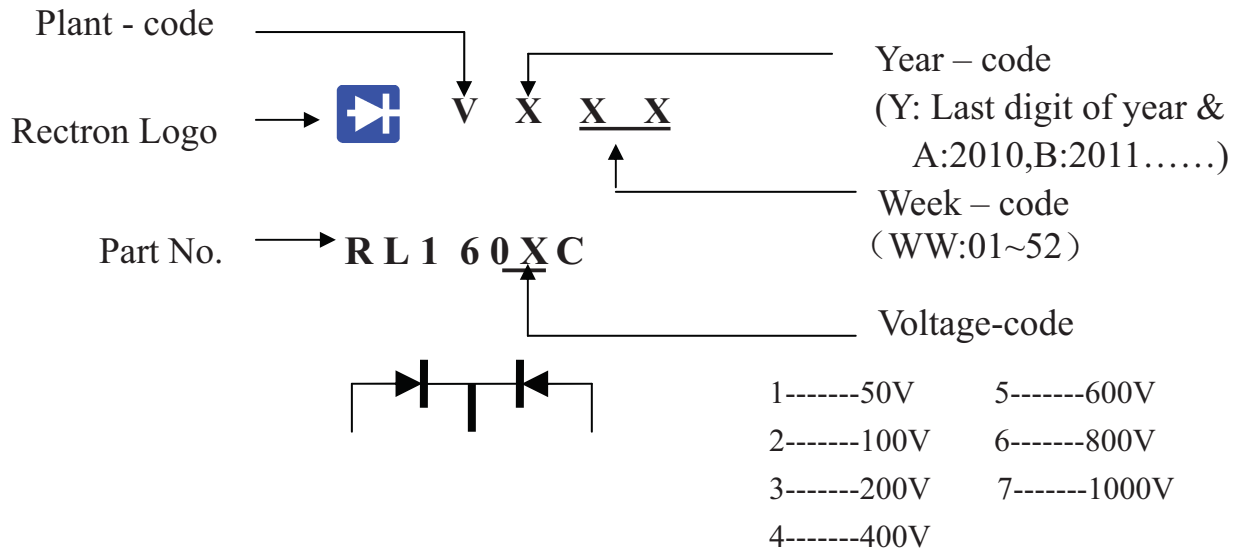

PACKAGING OF DIODE AND BRIDGE RECTIFIERS

TUBE PACK

PACKAGE	PACKING CODE	EA PER BOX	INNER BOX SIZE (mm)	CARTON SIZE (mm)	EA PER CARTON	WEIGHT(Kg)
(I)TO-220/TO-220(A)	-C	2,000	550*140*92	572*308*120	4,000	11.80

DISCLAIMER NOTICE

Rectron Inc reserves the right to make changes without notice to any product specification herein, to make corrections, modifications, enhancements or other changes. Rectron Inc or anyone on its behalf assumes no responsibility or liability for any errors or inaccuracies. Data sheet specifications and its information contained are intended to provide a product description only. "Typical" parameters which may be included on RECTRON data sheets and/ or specifications can and do vary in different applications and actual performance may vary over time. Rectron Inc does not assume any liability arising out of the application or use of any product or circuit.

Rectron products are not designed, intended or authorized for use in medical, life-saving implant or other applications intended for life-sustaining or other related applications where a failure or malfunction of component or circuitry may directly or indirectly cause injury or threaten a life without expressed written approval of Rectron Inc. Customers using or selling Rectron components for use in such applications do so at their own risk and shall agree to fully indemnify Rectron Inc and its subsidiaries harmless against all claims, damages and expenditures.