

**GLASS PASSIVATED JUNCTION
SILICON RECTIFIER**

VOLTAGE RANGE 50 to 1000 Volts CURRENT 1.0 Ampere

FEATURES

- * High reliability
- * Low leakage current
- * Low forward voltage drop
- * High current capability
- * Glass passivated junction
- * P/N suffix V means AEC-Q101 qualified, e.g:RL1N4001GV
- * P/N suffix V means Halogen-free

MECHANICAL DATA

- * Case : Molded plastic
- * Epoxy : Device has UL flammability classification 94V-0
- * Lead : MIL-STD-202E method 208C guaranteed
- * Mounting position : Any
- * Weight : 0.20 gram



A-405

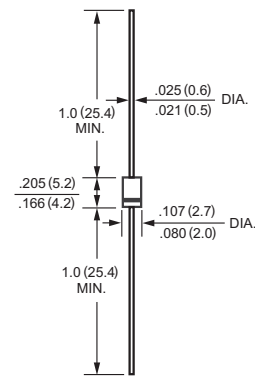

Dimensions in inches and (millimeters)

MAXIMUM RATINGS AND ELECTRICAL CHARACTERISTICS

Ratings at 25 °C ambient temperature unless otherwise specified.
Single phase, half wave, 60 Hz, resistive or inductive load.
For capacitive load, derate current by 20%.

MAXIMUM RATINGS (@ TA=25 °C unless otherwise noted)

RATINGS	SYMBOL	RL1N4001G	RL1N4002G	RL1N4003G	RL1N4004G	RL1N4005G	RL1N4006G	RL1N4007G	UNITS
Maximum Recurrent Peak Reverse Voltage	V_{RRM}	50	100	200	400	600	800	1000	Volts
Maximum RMS Voltage	V_{RMS}	35	70	140	280	420	560	700	Volts
Maximum DC Blocking Voltage	V_{DC}	50	100	200	400	600	800	1000	Volts
Maximum Average Forward Rectified Current at TA=75°C	I_O	1.0							Amps
Peak Forward Surge Current 8.3 ms single half sine-wave superimposed on rated load (JEDEC method)	I_{FSM}	30							Amps
Typical Current Squared Time	I^2t	3.74							A ² S
Typical Thermal Resistance	$R_{\theta JA}$	50							°C/W
Typical Junction Capacitance (Note 1)	C_J	15							pF
Operating and Storage Temperature Range	$T_{J,TSTG}$	-55 to + 150							°C

ELECTRICAL CHARACTERISTICS (@TA=25 °C unless otherwise noted)

CHARACTERISTICS	SYMBOL	RL1N4001G	RL1N4002G	RL1N4003G	RL1N4004G	RL1N4005G	RL1N4006G	RL1N4007G	UNITS
Maximum Instantaneous Forward Voltage at 1.0A DC	V_F	1.1							Volts
Maximum DC Reverse Current at Rated DC Blocking Voltage	@TA = 25 °C	5.0							uA
	@TA = 150 °C	1.0							mA
Maximum Full Load Reverse Current Average, Full Cycle .375" (9.5mm) lead length at TL=75°C		30							uA

NOTES : 1. Measured at 1 MHz and applied reverse voltage of 4.0 volts.
2. " ROHS compliant".

2018-04
REV: C

RATING AND CHARACTERISTICS CURVES (RL1N4001G THRU RL1N4007G)

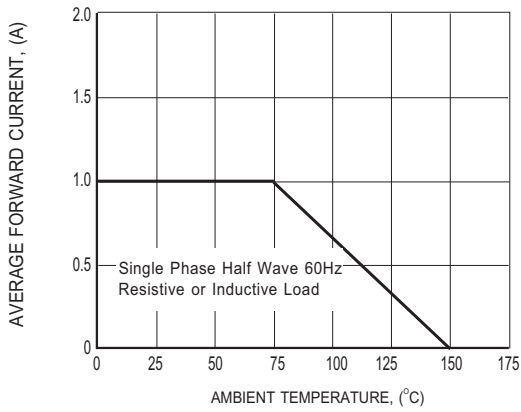

FIG.1 TYPICAL FORWARD CURRENT DERATING CURVE

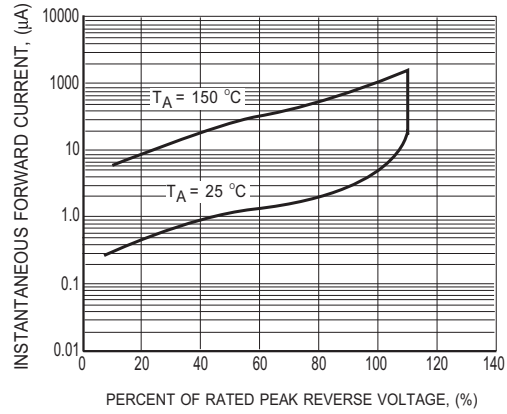

FIG.2 MAXIMUM REVERSE CHARACTERISTICS

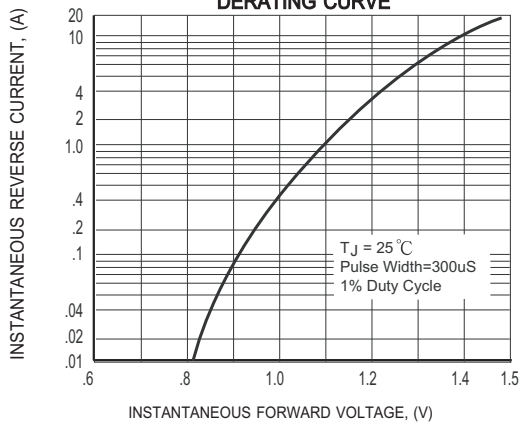

FIG.3 MAXIMUM INSTANTANEOUS FORWARD CHARACTERISTICS

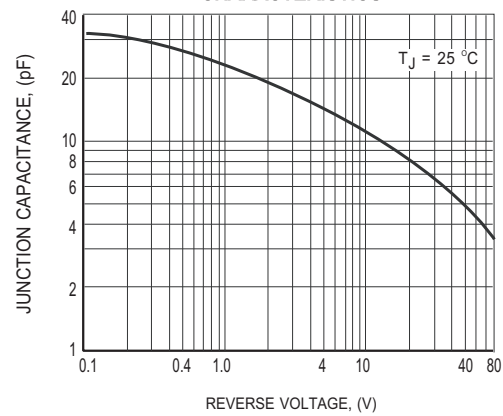

FIG.4 TYPICAL JUNCTION CAPACITANCE

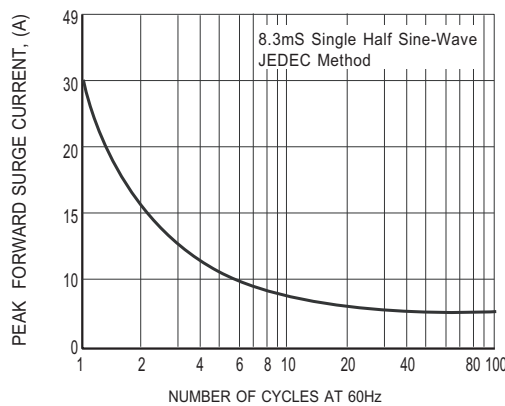
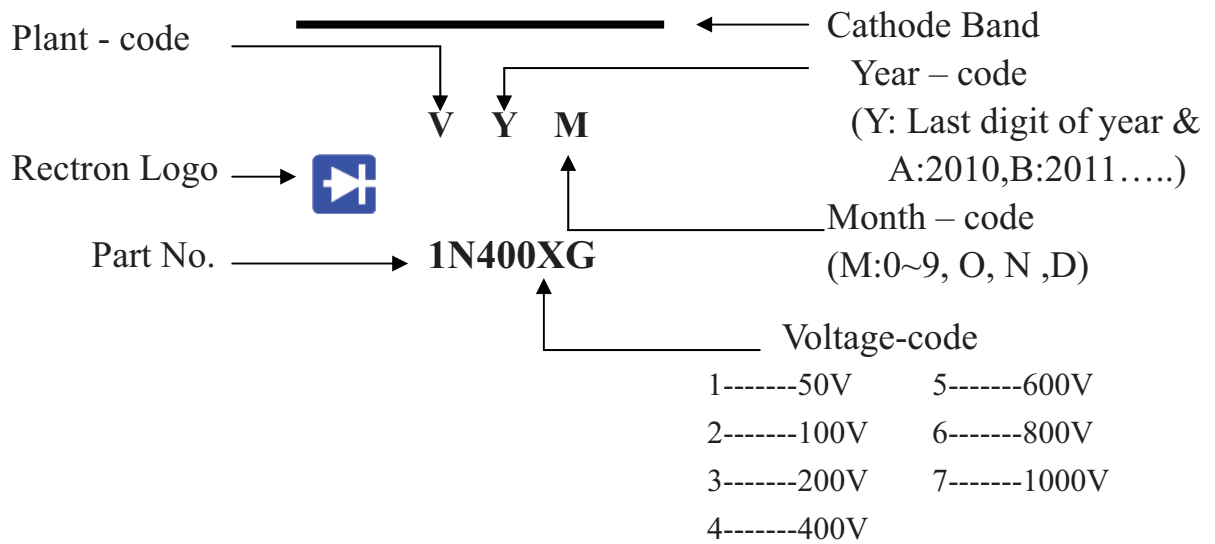

FIG.5 MAXIMUM NON-REPETITIVE FORWARD SURGE CURRENT

Mark Description



PACKAGING OF DIODE AND BRIDGE RECTIFIERS

BULK PACK

PACKAGE	PACKING CODE	EA PER BOX	INNER BOX SIZE (mm)	CARTON SIZE (mm)	EA PER CARTON	GROSS WEIGHT(Kg)
A-405	-B	1,000	194*84*21	415*220*255	50,000	15.64

REEL PACK

PACKAGE	PACKING CODE	EA PER REEL	EA PER INNER BOX	COMPONENT SPACE (mm)	TAPE SPACE (mm)	REEL DIA (mm)	CARTON SIZE (mm)	EA PER CARTON	GROSS WEIGHT(Kg)
DO-41	-T	5,000	5,000	5.0	52	330	355*350*335	20,000	8.13

AMMO PACK

PACKAGE	PACKING CODE	REEL (EA)	COMPONENT SPACE(mm)	TAPE SPACE (mm)	BOX SIZE (mm)	CARTON SIZE(mm)	CARTON (EA)	GROSS WEIGHT (Kg)
DO-41	-F	3,000	5.0	52	255*73*100	400*268*225	30,000	9.6
DO-41	-E	3,000	5.0	26	256*48*94	365*270*217	42,000	9.61
A-405	-N	2,000	12.7	---	325*170*40	355*350*335	28,000	11.41

DISCLAIMER NOTICE

Rectron Inc reserves the right to make changes without notice to any product specification herein, to make corrections, modifications, enhancements or other changes. Rectron Inc or anyone on its behalf assumes no responsibility or liability for any errors or inaccuracies. Data sheet specifications and its information contained are intended to provide a product description only. "Typical" parameters which may be included on RECTRON data sheets and/ or specifications can and do vary in different applications and actual performance may vary over time. Rectron Inc does not assume any liability arising out of the application or use of any product or circuit.

Rectron products are not designed, intended or authorized for use in medical, life-saving implant or other applications intended for life-sustaining or other related applications where a failure or malfunction of component or circuitry may directly or indirectly cause injury or threaten a life without expressed written approval of Rectron Inc. Customers using or selling Rectron components for use in such applications do so at their own risk and shall agree to fully indemnify Rectron Inc and its subsidiaries harmless against all claims, damages and expenditures.