

GLASS PASSIVATED SILICON RECTIFIER

VOLTAGE RANGE 50 to 1000 Volts CURRENT 8.0 Amperes

FEATURES

- * Low leakage
- * Low forward voltage drop
- * High current capability
- * High surge capability
- * High reliability

MECHANICAL DATA

- * Case: D-PAK molded plastic
- * Epoxy: Device has UL flammability classification 94V-0
- * Lead: MIL-STD-202E method 208C guaranteed
- * Mounting position: Any

MAXIMUM RATINGS AND ELECTRICAL CHARACTERISTICS

Ratings at 25 °C ambient temperature unless otherwise specified.
Single phase, half wave, 60 Hz, resistive or inductive load.
For capacitive load, derate current by 20%.

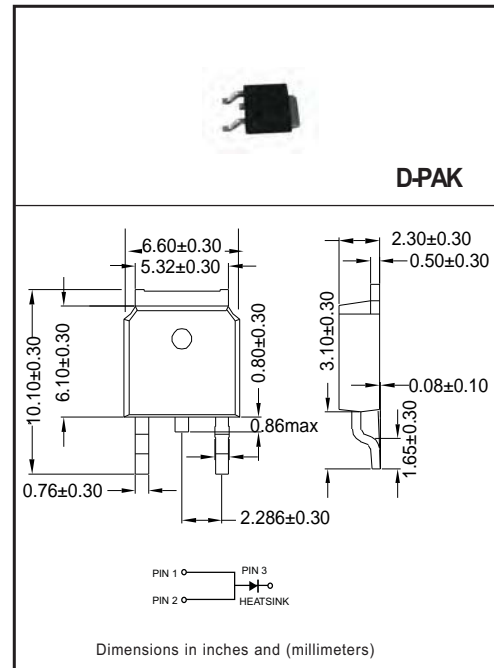

MAXIMUM RATINGS (@ TA=25 °C unless otherwise noted)

RATINGS	SYMBOL	RL801K	RL802K	RL803K	RL804K	RL805K	RL806K	RL807K	UNITS
Maximum Recurrent Peak Reverse Voltage	V _{RRM}	50	100	200	400	600	800	1000	Volts
Maximum RMS Voltage	V _{RMS}	35	70	140	280	420	560	700	Volts
Maximum DC Blocking Voltage	V _{DC}	50	100	200	400	600	800	1000	Volts
Maximum Average Forward Rectified Current at T _C = 100 °C	I _O	8.0							Amps
Peak Forward Surge Current 8.3 ms single half sine-wave superimposed on rated load (JEDEC method)	I _{FSM}	125							Amps
Typical Current Squarad Time	i ² t	64.84							A ² /Sec
Typical Thermal Resistance (Note 1)	R _{θJC}	3.6							°C/W
	R _{θJA}	25							
Typical Junction Capacitance (Note 2)	C _J	40							pF
Operating and Storage Temperature Range	T _J , T _{STG}	-55 to + 150							°C

ELECTRICAL CHARACTERISTICS (@TA=25 °C unless otherwise noted)

CHARACTERISTICS	SYMBOL	RL801K	RL802K	RL803K	RL804K	RL805K	RL806K	RL807K	UNITS
Maximum Instantaneous Forward Voltage at 8.0A DC	V _F	1.1							Volts
Maximum DC Reverse Current at Rated DC Blocking Voltage	@T _A = 25°C	2							uAmps
	@T _A = 100°C	100							

- NOTES : 1. Thermal Resistance : Heat-sink case mounted or if PCB mounted.
2. Measured at 1 MHz and applied reverse voltage of 4.0 volts.
3. "ROHS compliant"
4. Suffix "R" for Reverse Polarity.
5. Suffix "S" for D2-PAK Pkg.

RATING AND CHARACTERISTICS CURVES (RL801K THRU RL807K)

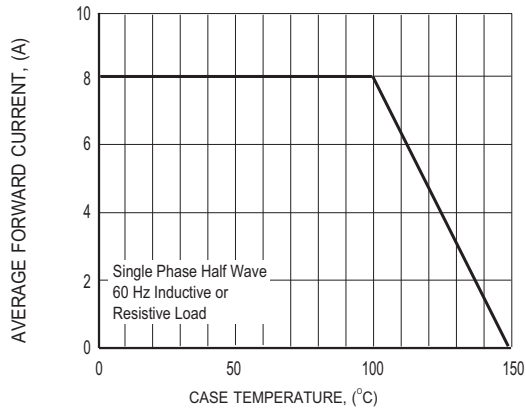

FIG.1 TYPICAL FORWARD CURRENT DERATING CURVE

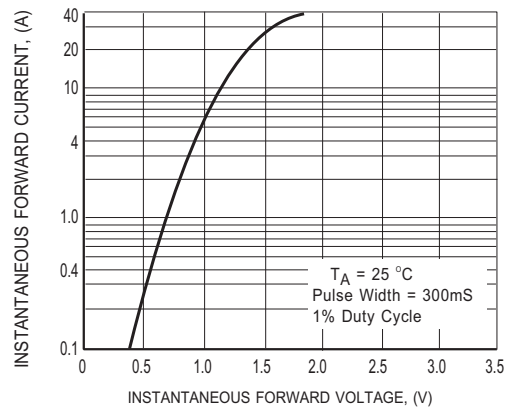

FIG.2 TYPICAL INSTANTANEOUS FORWARD CHARACTERISTICS

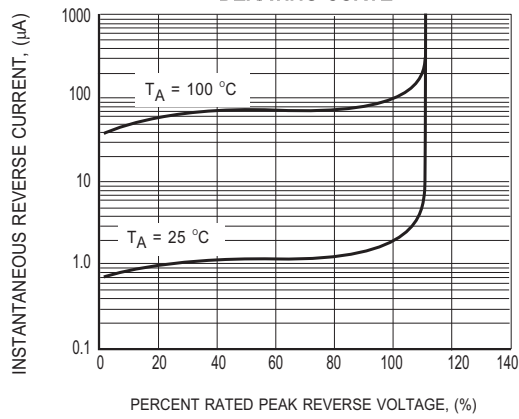

FIG.3 TYPICAL REVERSE CHARACTERISTICS

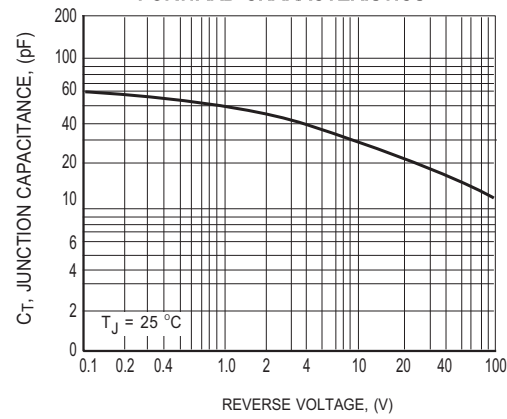

FIG.4 TYPICAL JUNCTION CAPACITANCE

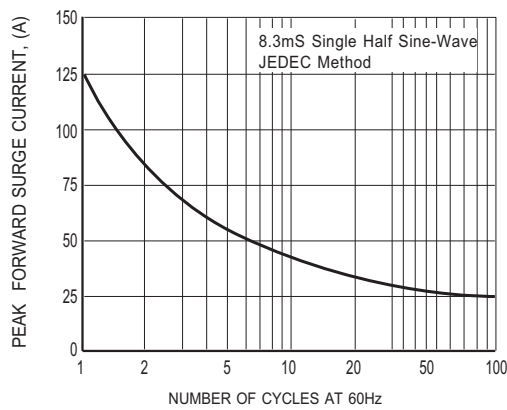
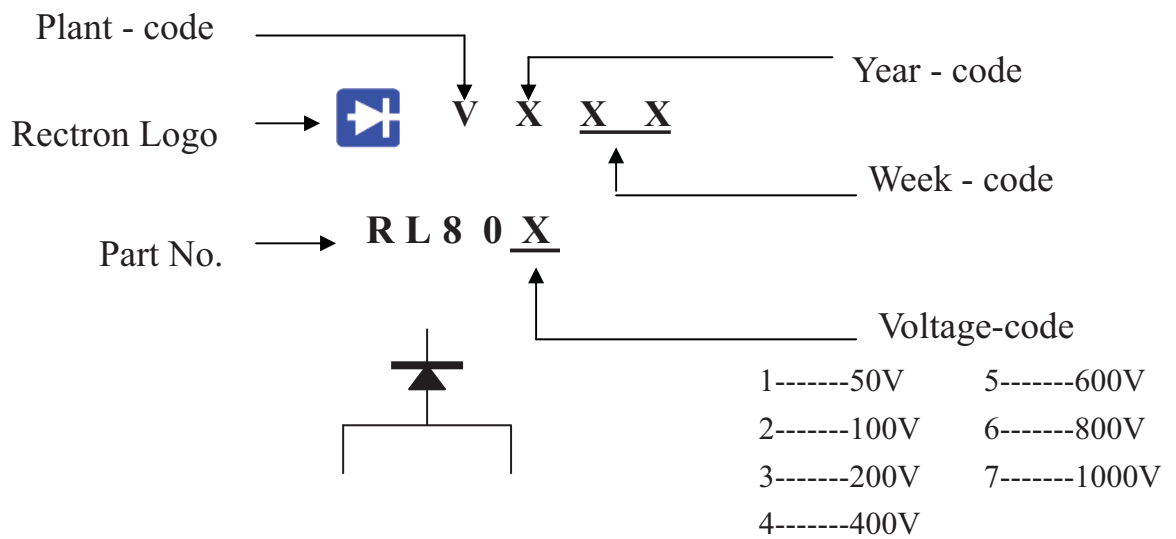

FIG.5 MAXIMUM NON-REPETITIVE FORWARD SURGE CURRENT

Marking on the body



PACKAGING OF DIODE AND BRIDGE RECTIFIERS

REEL PACK

PACKAGE	PACKING CODE	EA PER REEL	EA PER INNER BOX	BOX SIZE (mm)	CARTON SIZE (mm)	EA PER CARTON	GROSS WEIGHT(Kg)
DPAK	-W/-C	2,500	2,500	338*338*40	360*355*360	20,000	---

DISCLAIMER NOTICE

Rectron Inc reserves the right to make changes without notice to any product specification herein, to make corrections, modifications, enhancements or other changes. Rectron Inc or anyone on its behalf assumes no responsibility or liability for any errors or inaccuracies. Data sheet specifications and its information contained are intended to provide a product description only. "Typical" parameters which may be included on RECTRON data sheets and/ or specifications can and do vary in different applications and actual performance may vary over time. Rectron Inc does not assume any liability arising out of the application or use of any product or circuit.

Rectron products are not designed, intended or authorized for use in medical, life-saving implant or other applications intended for life-sustaining or other related applications where a failure or malfunction of component or circuitry may directly or indirectly cause injury or threaten a life without expressed written approval of Rectron Inc. Customers using or selling Rectron components for use in such applications do so at their own risk and shall agree to fully indemnify Rectron Inc and its subsidiaries harmless against all claims, damages and expenditures.