

N-Channel MOSFET 600V, 0.4 A, 8.5 Ω

Features

- $V_{DS} = 600V$
- $I_D = 0.4A$ @ $V_{GS} = 10V$
- $R_{DS(ON)} \leq 8.5\Omega$ @ $V_{GS} = 10V$

Applications

- Power supply
- Battery charger
- Ballast

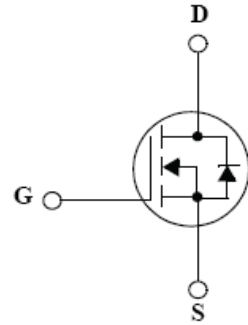

Absolute Maximum Ratings (Ta = 25°C)

Characteristics	Symbol	Rating	Unit
Drain-Source Voltage	V_{DSS}	600	V
Gate-Source Voltage	V_{GSS}	±30	V
Continuous Drain Current	I_D	$T_C=25^\circ C$	0.4 A
		$T_C=100^\circ C$	0.25 A
Pulsed Drain Current ⁽¹⁾	I_{DM}	1.6	A
Power Dissipation	P_D	$T_C=25^\circ C$	2.5 W
		Derate above 25 °C	0.02 W/°C
Peak Diode Recovery dv/dt ⁽³⁾	Dv/dt	4.5	V/ns
Single Pulse Avalanche Energy ⁽⁴⁾	E_{AS}	30	mJ
Junction and Storage Temperature Range	T_J, T_{stg}	-55~150	°C

Thermal Characteristics

Characteristics	Symbol	Rating	Unit
Thermal Resistance, Junction-to-Lead ⁽¹⁾	$R_{\theta JL}$	50	°C/W
Thermal Resistance, Junction-to-Ambient	$R_{\theta JA}$	140	

Ordering Information

Part Number	Temp. Range	Package	Packing	RoHS Status
RMA4N60092	-55~150°C	TO-92	AMMOPAK	Halogen Free

Electrical Characteristics (Ta = 25°C)

Characteristics	Symbol	Test Condition	Min	Typ	Max	Unit
Static Characteristics						
Drain-Source Breakdown Voltage	BV_{DSS}	$I_D = 250\mu A, V_{GS} = 0V$	600	-	-	V
Gate Threshold Voltage	$V_{GS(th)}$	$V_{DS} = V_{GS}, I_D = 250\mu A$	3.0	-	5.0	
Drain Cut-Off Current	I_{DSS}	$V_{DS} = 600V, V_{GS} = 0V$	-	-	1	μA
Gate Leakage Current	I_{GSS}	$V_{GS} = \pm 30V, V_{DS} = 0V$	-	-	100	nA
Drain-Source ON Resistance	$R_{DS(ON)}$	$V_{GS} = 10V, I_D = 0.2A$		7.0	8.5	Ω
Forward Transconductance	g_{fs}	$V_{DS} = 30V, I_D = 0.4A$	-	0.75	-	S

Dynamic Characteristics

Total Gate Charge	Q_g	$V_{DS} = 600V, I_D = 1.0A, V_{GS} = 10V^{(3)}$	-	3.5		nC
Gate-Source Charge	Q_{gs}		-	1.4		
Gate-Drain Charge	Q_{gd}		-	1.4		
Input Capacitance	C_{iss}	$V_{DS} = 25V, V_{GS} = 0V, f = 1.0MHz$	-	130		pF
Reverse Transfer Capacitance	C_{riss}		-	18.5		
Output Capacitance	C_{oss}		-	1.0		
Turn-On Delay Time	$t_{d(on)}$	$V_{GS} = 10V, V_{DS} = 300V, I_D = 1.0A, R_G = 25\Omega^{(3)}$	-	7.5		ns
Rise Time	t_r		-	17		
Turn-Off Delay Time	$t_{d(off)}$		-	8.5		
Fall Time	t_f		-	22		

Drain-Source Body Diode Characteristics

Maximum Continuous Drain to Source Diode Forward Current	I_S		-	0.4	-	A
Source-Drain Diode Forward Voltage	V_{SD}	$I_S = 0.4A, V_{GS} = 0V$	-		1.4	V
Body Diode Reverse Recovery Time	t_{rr}	$I_F = 1.0A, di/dt = 100A/\mu s^{(3)}$	-	200		ns
Body Diode Reverse Recovery Charge	Q_{rr}		-	480		nC

Note :

- $R_{\theta JL}$ point is the drain lead.
- Pulse test: pulse width $\leq 300\mu s$, duty cycle $\leq 2\%$, pulse width limited by junction temperature $T_J(MAX) = 150^\circ C$
- $I_{SD} \leq 1.0A$, $di/dt \leq 200A/\mu s$, $V_{DD} = 50V$, $R_g = 25\Omega$, Starting $T_J = 25^\circ C$
- $L = 55mH$, $I_{AS} = 1.0A$, $V_{DD} = 50V$, $R_g = 25\Omega$, Starting $T_J = 25^\circ C$

RATING AND CHARACTERISTICS CURVES (RMA4N60092)

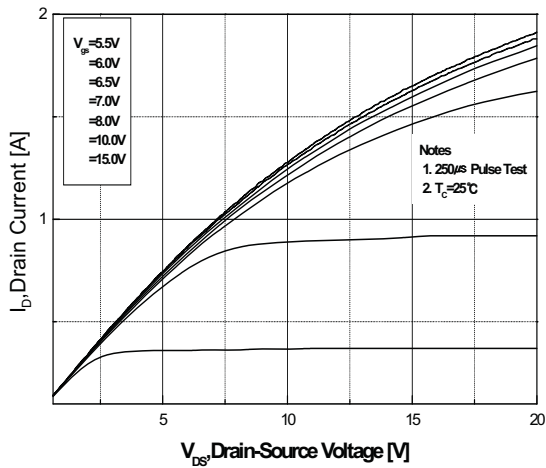

Fig.1 On-Region Characteristics

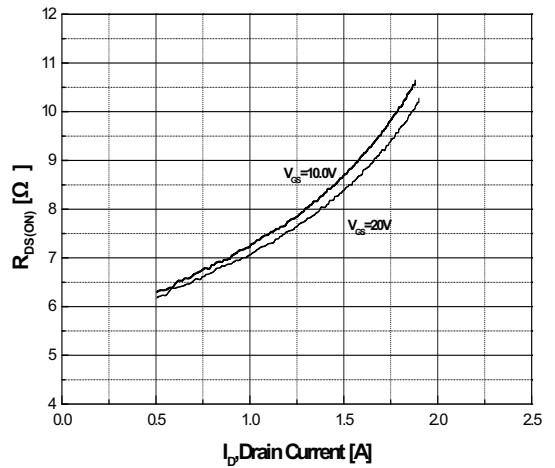

Fig.2 On-Resistance Variation with Drain Current and Gate Voltage

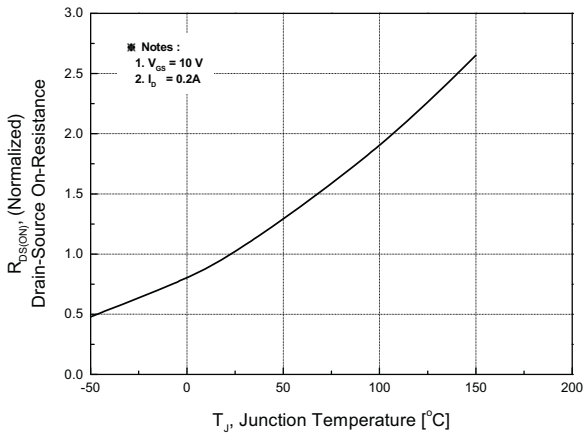

Fig.3 On-Resistance Variation with Temperature

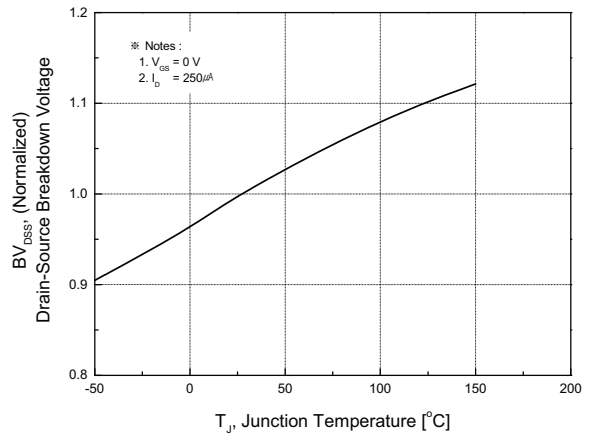

Fig.4 Breakdown Voltage Variation vs. Temperature

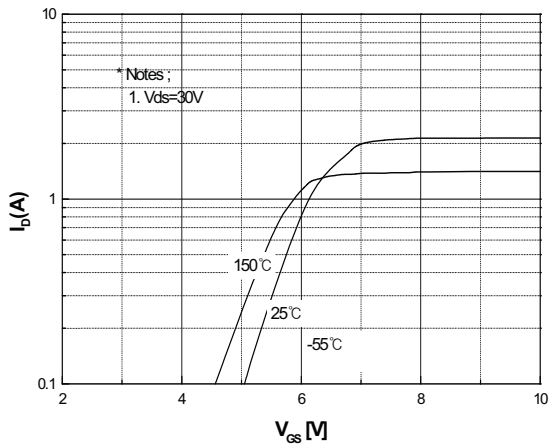

Fig.5 Transfer Characteristics

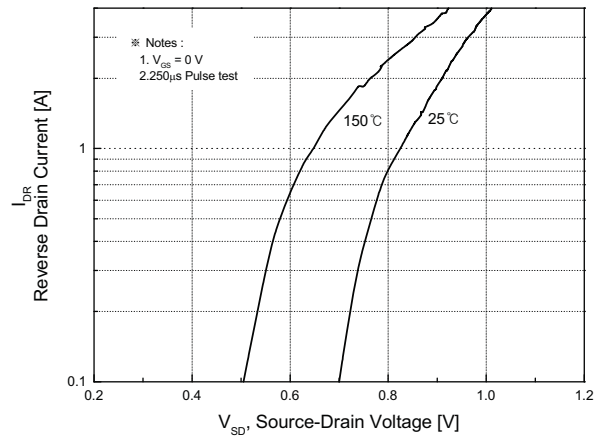
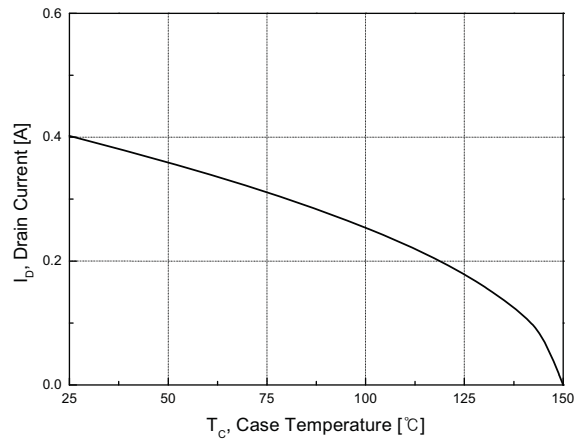
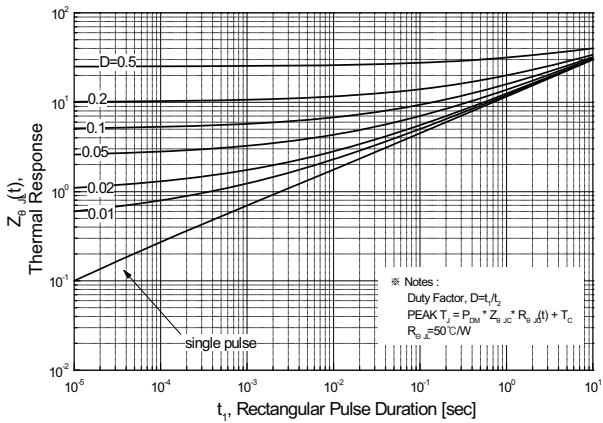
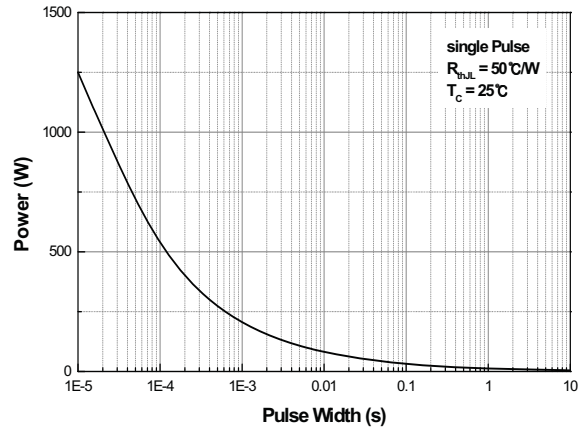
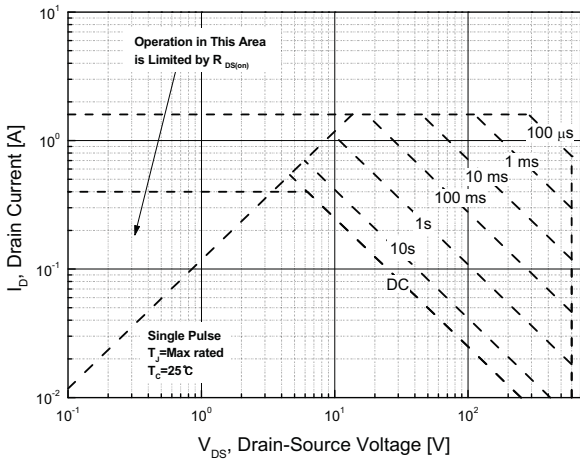
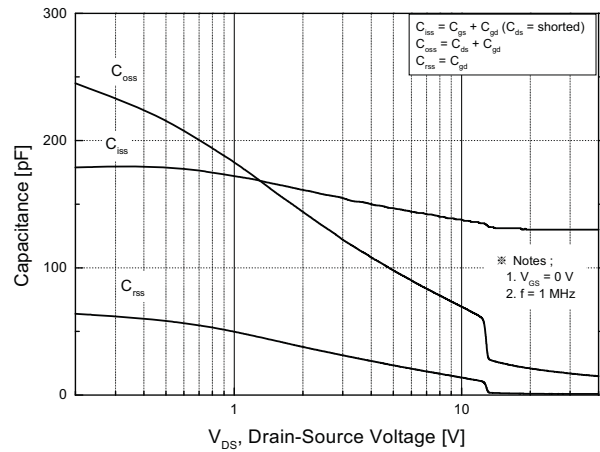
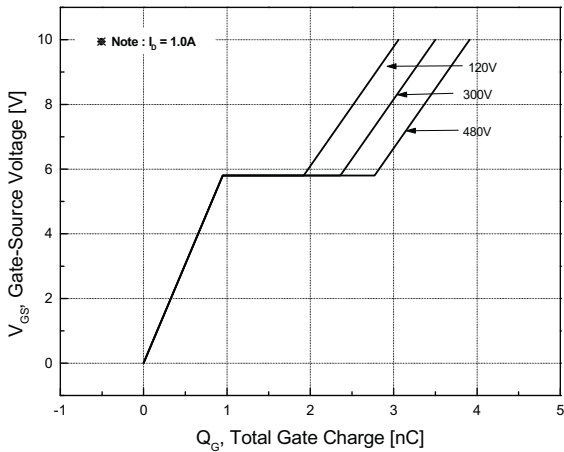

Fig.6 Body Diode Forward Voltage Variation with Source Current and Temperature

RATING AND CHARACTERISTICS CURVES (RMA4N60092)



Physical Dimensions

TO-92-3L, AMMO Packing

Dimensions are in millimeters unless otherwise specified

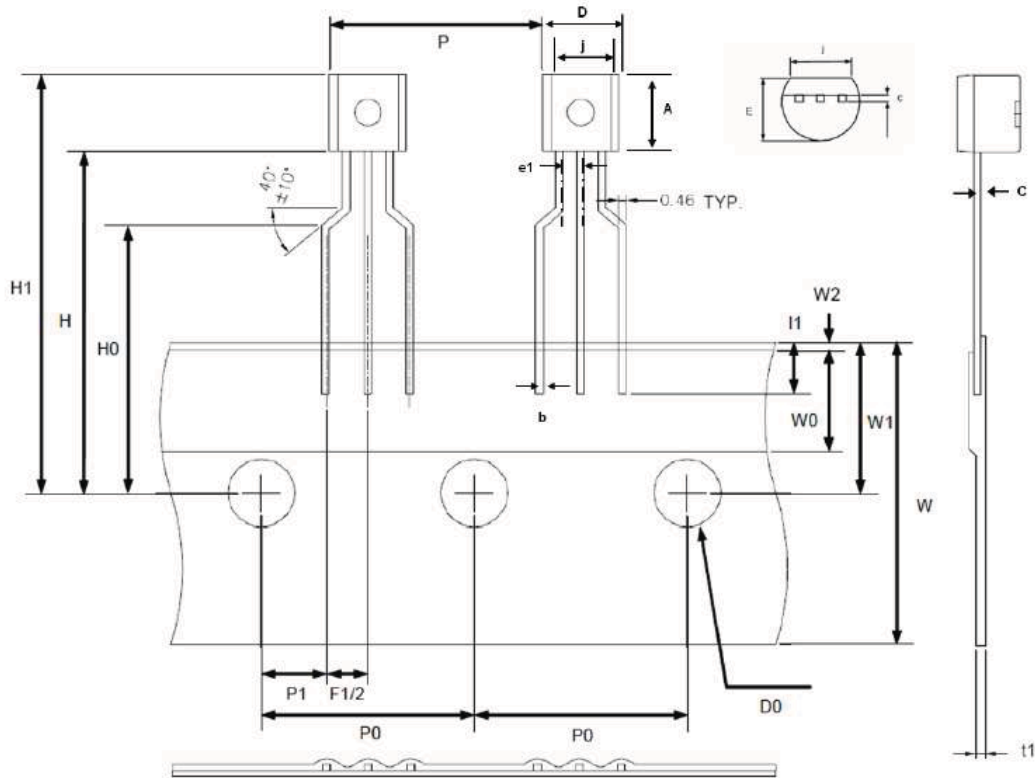

Symbol	Min	Max
A	4.32	5.34
b	0.36	0.56
c	0.36	0.52
D	4.43	5.20
D0	3.70	4.30
E		3.86
e1	1.07	1.47
l1	2.50	
F1/F2	2.40	2.94
H		27.68
H0		20.82
H1		32.00
j	3.40	
P	11.70	13.70
P0	12.40	13.00
P1	3.35	4.35
T1	0.38	0.69
W	17.50	19.00
W0	5.50	6.50
W1	8.50	9.80
W2		0.90

DISCLAIMER NOTICE

Rectron Inc reserves the right to make changes without notice to any product specification herein, to make corrections, modifications, enhancements or other changes. Rectron Inc or anyone on its behalf assumes no responsibility or liability for any errors or inaccuracies. Data sheet specifications and its information contained are intended to provide a product description only. "Typical" parameters which may be included on RECTRON data sheets and/ or specifications can and do vary in different applications and actual performance may vary over time. Rectron Inc does not assume any liability arising out of the application or use of any product or circuit.

Rectron products are not designed, intended or authorized for use in medical, life-saving implant or other applications intended for life-sustaining or other related applications where a failure or malfunction of component or circuitry may directly or indirectly cause injury or threaten a life without expressed written approval of Rectron Inc. Customers using or selling Rectron components for use in such applications do so at their own risk and shall agree to fully indemnify Rectron Inc and its subsidiaries harmless against all claims, damages and expenditures.